



X-C B4 MX,  
X-C B3 MX,  
X-C G3 MX,  
X-C G2 MX,  
X-GN MX

**Concrete nails (collated)**

Data Sheet

[English](#)

[Deutsch](#)

[Français](#)

[Español](#)

[Italiano](#)

[Polski](#)

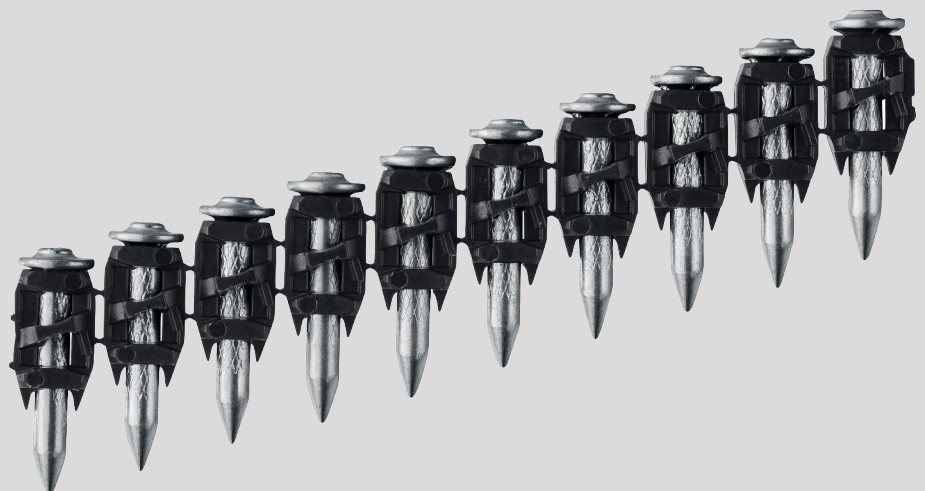



X-C B4 MX,  
X-C B3 MX,  
X-C G3 MX,  
X-C G2 MX,  
X-GN MX

**Concrete nails (collated)**

Data Sheet

[English](#)

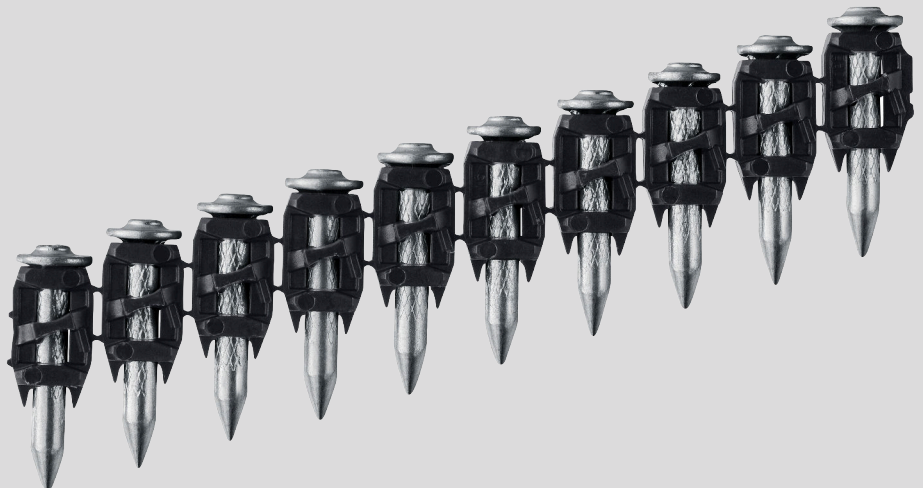





# CONTENTS

<b>1</b>	<b>Product information</b>	<b>2</b>
1.1	Product description	2
<b>2</b>	<b>Application conditions</b>	<b>3</b>
2.1	Fastening conditions	3
2.2	Base materials	3
2.3	Load conditions	3
2.4	Environmental conditions	4
<b>3</b>	<b>Product data</b>	<b>4</b>
3.1	Dimensions	4
3.2	Material properties for carbon steel parts	4
<b>4</b>	<b>System recommendation</b>	<b>5</b>
4.1	Tool recommendation	5
<b>5</b>	<b>Application requirements</b>	<b>6</b>
5.1	Fastened material properties	6
5.2	Base material properties	7
5.3	Nail length recommendation	7
<b>6</b>	<b>Performance data</b>	<b>8</b>
6.1	Recommended loads under quasi static/static loading	8
6.2	Stick rate estimation	8
<b>7</b>	<b>Quality assurance</b>	<b>9</b>
7.1	Fastening inspection	9
<b>8</b>	<b>Ordering information</b>	<b>10</b>
8.1	Item number and description	10

# 1 PRODUCT INFORMATION

## 1.1 Product description

Designation	Features
<p>X-C B4 MX</p> 	
<p>X-C B3 MX</p> 	
<p>X-C G3 MX</p> 	<ul style="list-style-type: none"> <li>• Premium nail for excellent performance on soft concrete</li> <li>• Everyday fastening solution with cut-tip nail</li> </ul>
<p>X-C G2 MX</p> 	
<p>X-GN MX</p> 	

## 2 APPLICATION CONDITIONS

### 2.1 Fastening conditions

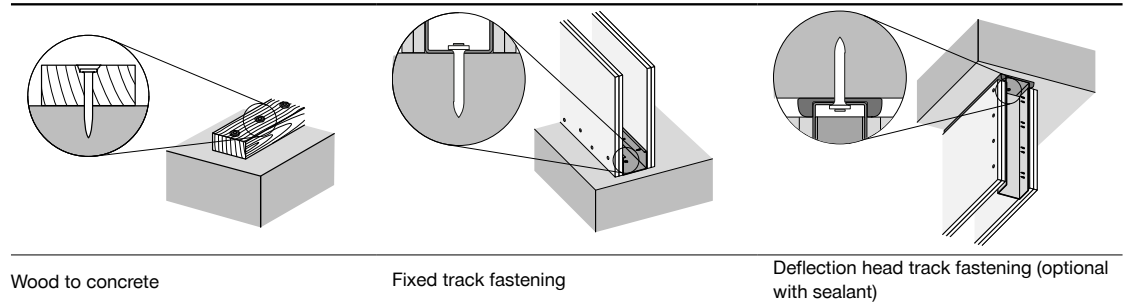

Wood to concrete

Fixed track fastening

Deflection head track fastening (optional with sealant)

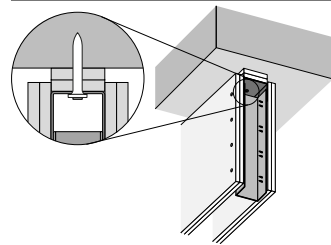

Deflection head fastening with gypsum strips (optional with sealant)

### 2.2 Base materials

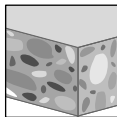

Concrete

### 2.3 Load conditions



Static / quasi-static

## 2.4 Environmental conditions

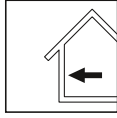

Dry indoor



• For more details, please refer to the [Hilti Corrosion Handbook](#).

## 3 PRODUCT DATA

### 3.1 Dimensions

Technical drawing	Fastener	Head length	Shank length	Shank diameter	Head diameter
		$L_h$ [mm]	$L_s$ [mm]	$d_s$ [mm]	$d_h$ [mm]
	X-C 20 B4 MX	1.8	20	3	6.5
	X-C 27 B4 MX	1.8	27	3	6.5
	X-C 32 B4 MX	1.8	32	3	6.5
	X-C 39 B4 MX	1.8	37.5	2.75	6.3
	X-C 45 B4 MX	1.8	45	2.75	6.3
	X-C 20 B3 MX	1.8	20	3	6.8
	X-C 24 B3 MX	1.9	24	3	6.5
	X-C 27 B3 MX	1.9	27	3	6.5
	X-C 30 B3 MX	1.9	30	3	6.5
	X-C 36 B3 MX	1.8	36	2.75	6.3
	X-C 20 G3 MX	1.9	19	3	6.5
	X-C 27 G3 MX	1.9	27	3	6.5
	X-C 32 G3 MX	1.9	30	3	6.5
	X-C 39 G3 MX	1.9	38.5	2.6	5.8
	X-C 20 G2 MX	1.8	19.05	2.75	6.3
	X-C 27 G2 MX	1.8	27.4	2.75	6.3
	X-C 39 G2 MX	1.9	38.5	2.6	5.8
	X-GN 20 MX	1.9	19	3	6.5
	X-GN 27 MX	1.9	27	3	6.5
	X-GN 32 MX	1.9	32	3	6.5
X-GN 39 MX	1.9	38.5	2.6	5.8	

### 3.2 Material properties for carbon steel parts

Fastener	Component part	Material	Coating	Coating thickness	Hardness	Corrosivity category
				$t_c$ [μm]	[HRC]	
X-C B4 MX	Nail	Carbon steel	Zinc coated	≥5	56.5	C1

Fastener	Component part	Material	Coating	Coating thickness	Hardness	Corrosivity category
				t <sub>c</sub> [μm]	[HRC]	
X-C B3 MX	Nail	Carbon steel	Zinc coated	≥5	56.5	C1
X-C G3 MX	Nail	Carbon steel	Zinc coated	≥5	56.5	C1
X-C G2 MX	Nail	Carbon steel	Zinc coated	≥5	56.5	C1
X-GN 20 MX	Nail	Carbon steel	Zinc coated	≥5	53.5	C1
X-GN 27 MX	Nail	Carbon steel	Zinc coated	≥5	53.5	C1
X-GN 32 MX	Nail	Carbon steel	Zinc coated	≥5	53.5	C1
X-GN 39 MX	Nail	Carbon steel	Zinc coated	≥5	56.5	C1

• Corrosivity category of the atmosphere according to EN ISO 9223.

## 4 SYSTEM RECOMMENDATION

### 4.1 Tool recommendation

Fastening condition	Fastener	Tool type
Wood to concrete, Fixed track fastening, Deflection head track fastening (optional with sealant)	X-C B4 MX	BX 4-22 (01)
	X-C B3 MX	BX 3-ME, BX 3-IF, BX 3-ME (02), BX 3 (02), BX 3-L (02), BX 3-ME-22, BX 3-L-22, BX 3-22
	X-C G3 MX	GX 3-ME, GX 3
	X-C G2 MX	GX 2
	X-GN MX	GX 120-ME, GX 120
Deflection head fastening with gypsum strips (optional with sealant)	X-C 45 B4 MX	BX 4-22 (01)

• For more details, please refer to the chapter Accessories and consumables compatibility in the [Direct Fastening Technology Manual \(DFTM\)](#).

## 5 APPLICATION REQUIREMENTS

### 5.1 Fastened material properties

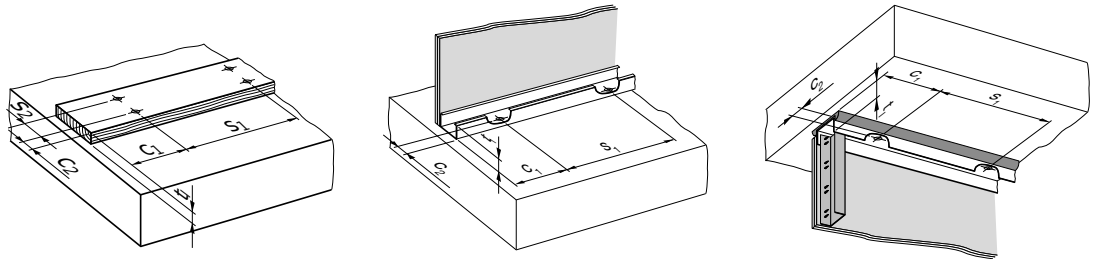

Wood to concrete

Fixed track fastening

Deflection head track fastening (optional with sealant)

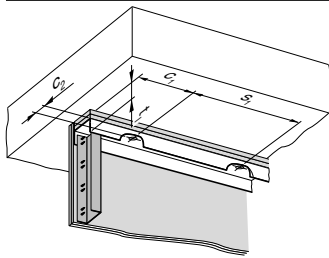

Deflection head fastening with gypsum strips (optional with sealant)

Fastening condition	Fastener	Fastened material	Fastened material thickness $t_1$ [mm]	Edge distance	Edge distance	Fastener spacing distance $s_1$ [mm]	Fastener spacing distance $s_2$ [mm]
				$c_1$ [mm]	$c_2$ [mm]		
Wood to concrete	X-C B4 MX, X-C B3 MX, X-C G3 MX, X-C G2 MX, X-GN MX	Wood	$\leq 25$	$\geq 100$	$\geq 22$	180 – 800	$\geq 80$
Fixed track fastening	X-C B4 MX, X-C B3 MX, X-C G3 MX, X-C G2 MX, X-GN MX	Steel track	$\leq 1$	$\geq 40$		$\leq 600$	$\geq 80$
Deflection head track fastening (optional with sealant)	X-C B4 MX, X-C B3 MX, X-C G3 MX, X-C G2 MX, X-GN MX	Steel track, Hilti CSF-TTS or sealant	$\leq 3.5$				
Deflection head fastening with gypsum strips (optional with sealant)	X-C 45 B4 MX	Steel track, Gypsum board	$\leq 33.5$				



## 5.2 Base material properties

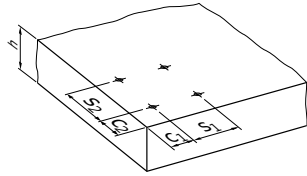

Fastening to concrete

Base material	Base material thickness h [mm]	Edge distance c <sub>1</sub> [mm]	Edge distance c <sub>2</sub> [mm]	Fastener spacing distance s <sub>1</sub> [mm]	Fastener spacing distance s <sub>2</sub> [mm]
Concrete	≥60	≥70	≥70	≥100	≥100

## 5.3 Nail length recommendation

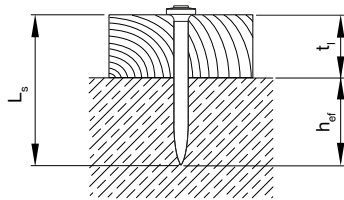

Wood to concrete

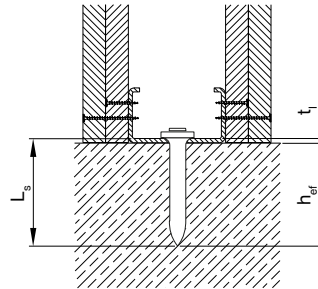

Fixed track fastening

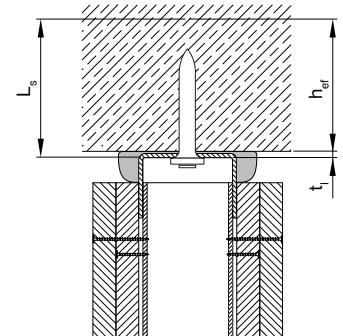

Deflection head track fastening (optional with sealant)

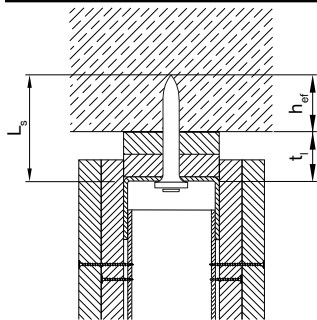

Deflection head fastening with gypsum strips (optional with sealant)

Fastening condition	Fastening characteristics	Shank Length	Embedment depth	Fastened material thickness
		$L_s$ [mm]	$h_{ef}$ [mm]	$t_f$ [mm]
Wood to concrete	Standard fastening	$L_s \geq h_{ef} + t_f$	$\geq 14$	$\leq 25$
	Flush fastening	$L_s \geq h_{ef} + t_f - 3$	$\geq 14$	$\leq 25$
Fixed track fastening	Standard fastening	$L_s \geq h_{ef} + t_f$	$\geq 14$	$\leq 1$
Deflection head track fastening (optional with sealant)	Standard fastening	$L_s \geq h_{ef} + t_f$	$\geq 14$	$\leq 3.5$
Deflection head fastening with gypsum strips (optional with sealant)	2 board layers	$L_s \geq h_{ef} + t_f$	$\geq 14$	$\leq 33.5$

## 6 PERFORMANCE DATA

### 6.1 Recommended loads under quasi static/static loading

Fastening condition	Fastener	Base material type	Embedment depth	Tension load	Shear load
			$h_{ef}$ [mm]	$N_{rec}$ [kN]	$V_{rec}$ [kN]
Wood to concrete, Fixed track fastening, Deflection head track fastening (optional with sealant)	X-C B4 MX, X-C B3 MX, X-C G3 MX, X-C G2 MX, X-GN MX	Soft concrete, Medium concrete	14 - < 18	0.1	0.1
		Soft concrete, Medium concrete	$\geq 18$	0.2	0.2
Deflection head fastening with gypsum strips (optional with sealant)	X-C 45 B4 MX	Soft concrete, Medium concrete	14 - < 18	0.1	0.1
		Soft concrete, Medium concrete	$\geq 18$	0.2	0.2

### 6.2 Stick rate estimation

Technical drawing	Fastening condition	Base material type	Stick rate estimation [%]
	Wood to concrete, Fixed track fastening, Deflection head track fastening (optional with sealant), Deflection head fastening with gypsum strips (optional with sealant)	Soft concrete	75-90
		Medium concrete	75-90



- Stick rate can vary from the above values depending on job site conditions.
- The stick rate indicates the percentage of nails that were driven correctly to carry a load.

## 7 QUALITY ASSURANCE

### 7.1 Fastening inspection

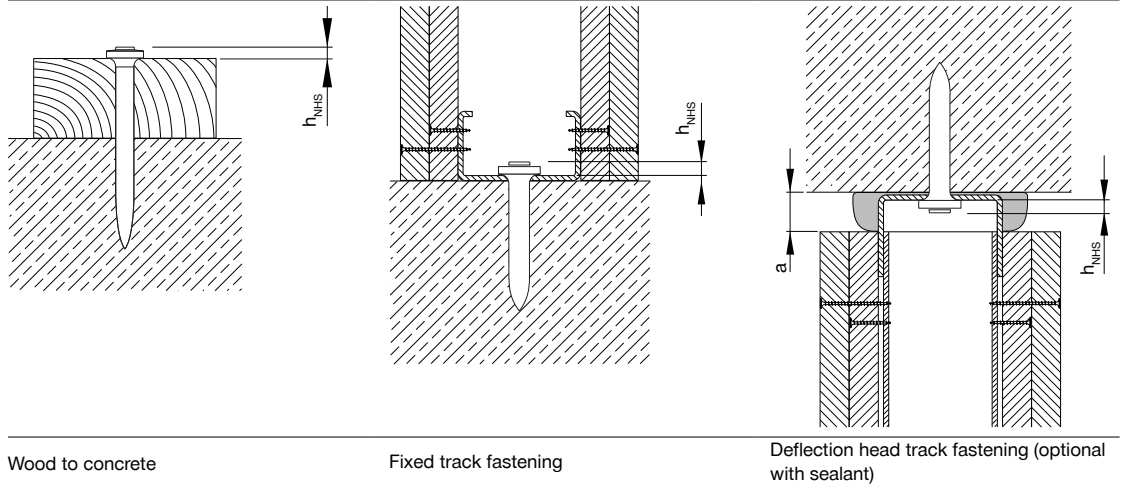

Wood to concrete

Fixed track fastening

Deflection head track fastening (optional with sealant)

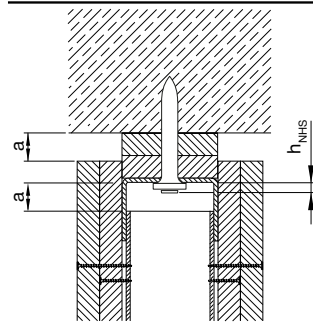

Deflection head fastening with gypsum strips (optional with sealant)

Fastening condition	Fastener	Deflection head gap a [mm]	Fastener standoff h <sub>NHS</sub> [mm]
Wood to concrete	X-C B4 MX, X-C B3 MX, X-C G3 MX, X-C G2 MX, X-GN MX		≤3
Fixed track fastening	X-C B4 MX, X-C B3 MX, X-C G3 MX, X-C G2 MX, X-GN MX		2 – 5
Deflection head track fastening (optional with sealant)	X-C B4 MX, X-C B3 MX, X-C G3 MX, X-C G2 MX, X-GN MX	≤20	2 – 3
Deflection head fastening with gypsum strips (optional with sealant)	X-C 45 B4 MX	≤20	2 – 3



- Visible setting failures must be replaced with a new fastener, not in the same hole.
- These are abbreviated instructions which may vary by application.
- Always review/ follow the instructions accompanying the product.

## 8 ORDERING INFORMATION

### 8.1 Item number and description

Designation	Item number	Description
X-C 20 B3 MX	2123993, 2246267	X-C B3 MX Concrete nails (collated)
X-C 24 B3 MX	2123994, 2314526	
X-C 27 B3 MX	2224568	
X-C 30 B3 MX	2149988, 2314527	
X-C 36 B3 MX	2149989	
X-C 20 B4 MX	2361658, 2361663, 2412651, 2412652	X-C B4 MX Concrete nails (collated)
X-C 27 B4 MX	2361659, 2361664, 2412653, 2412654	
X-C 32 B4 MX	2361660, 2361665, 2412655, 2412656	
X-C 39 B4 MX	2361661, 2361666, 2412657, 2412658	
X-C 45 B4 MX	2361662, 2361667, 2412659, 2412760	
X-C 20 G2 MX	2102013	X-C G2 MX Concrete nails (collated)
X-C 27 G2 MX	2102014	
X-C 39 G2 MX	3539617	
X-C 20 G3 MX	2100955, 2100959	X-C G3 MX Concrete nails (collated)
X-C 27 G3 MX	2100956, 2101040	
X-C 32 G3 MX	2100957	
X-C 39 G3 MX	2100958, 2122633	
X-GN 20 MX	2045541, 2064004, 2071406, 226933, 340232	X-GN MX Concrete nails (collated)
X-GN 27 MX	2045540, 2064005, 2071407, 226934, 340230	
X-GN 32 MX	2045542, 2064006, 2071408, 226935, 340233	
X-GN 39 MX	2064007, 340234	



Hilti Aktiengesellschaft  
9494 Schaan, Liechtenstein  
P +423-234 2965

[www.facebook.com/hiltigroup](https://www.facebook.com/hiltigroup)  
[www.hilti.group](https://www.hilti.group)



X-C B4 MX,  
X-C B3 MX,  
X-C G3 MX,  
X-C G2 MX,  
X-GN MX

**Nägel für Beton (magaziniert)**

Datenblatt

[Deutsch](#)

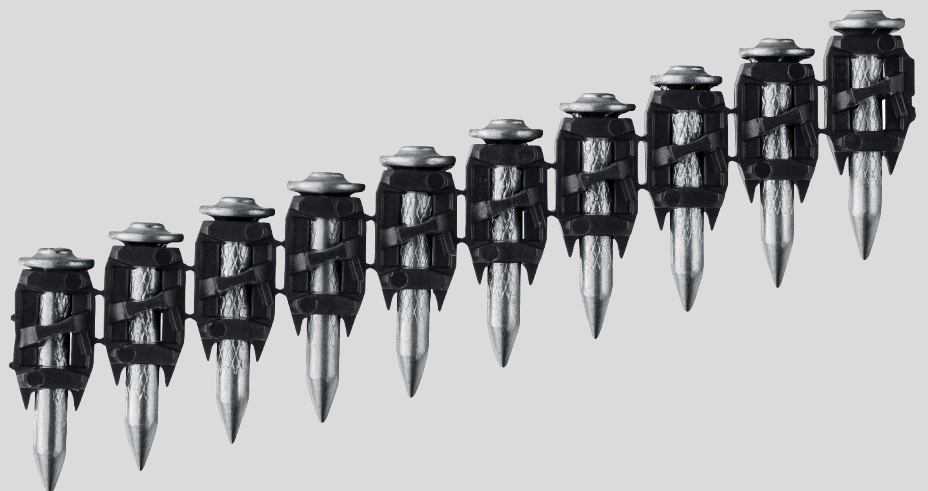





# INHALTSVERZEICHNIS

<b>1</b>	<b>Produktinformationen</b>	<b>2</b>
1.1	Produktbeschreibung	2
<b>2</b>	<b>Anwendungsbedingungen</b>	<b>3</b>
2.1	Befestigungsbedingungen	3
2.2	Untergrundmaterial	3
2.3	Lastbedingungen	3
2.4	Umgebungsbedingungen	4
<b>3</b>	<b>Produktdaten</b>	<b>4</b>
3.1	Abmessungen	4
3.2	Materialeigenschaften für Teile aus Kohlenstoffstahl	5
<b>4</b>	<b>Systemempfehlung</b>	<b>5</b>
4.1	Geräteempfehlung	5
<b>5</b>	<b>Anwendungsanforderungen</b>	<b>6</b>
5.1	Eigenschaften des befestigten Materials	6
5.2	Eigenschaften des Untergrundmaterials	7
5.3	Empfehlung zur Länge von Nägeln	7
<b>6</b>	<b>Leistungsdaten</b>	<b>8</b>
6.1	Empfohlene Lasten unter quasi-statischer/statischer Belastung	8
6.2	Erwartete Setzrate	8
<b>7</b>	<b>Qualitätssicherung</b>	<b>9</b>
7.1	Befestigungskontrolle	9
<b>8</b>	<b>Bestellinformationen</b>	<b>10</b>
8.1	Artikelnummer und Beschreibung	10

# 1 PRODUKTINFORMATIONEN

## 1.1 Produktbeschreibung

Bezeichnung	Besondere Eigenschaften
<p>X-C B4 MX</p> 	<ul style="list-style-type: none"> <li>• Premium-Nagel für hervorragende Leistung auf weichem Beton</li> <li>• Befestigungslösung für den Alltag mit Nagel mit geschnittener Spitze</li> </ul>
<p>X-C B3 MX</p> 	<ul style="list-style-type: none"> <li>• Premiumnagel mit ausgezeichneter Leistung auf weichem Beton</li> <li>• Wirtschaftlicher Standardnagel mit stumpfer Spitze</li> </ul>
<p>X-C G3 MX</p> 	<ul style="list-style-type: none"> <li>• Premiumnagel mit ausgezeichneter Leistung auf weichem Beton</li> <li>• Wirtschaftlicher Standardnagel mit geschnittener Spitze</li> </ul>
<p>X-C G2 MX</p> 	<ul style="list-style-type: none"> <li>• Premiumnagel mit ausgezeichneter Leistung auf weichem Beton</li> <li>• Befestigungslösung für den Alltag mit Nagel mit geschnittener Spitze</li> </ul>
<p>X-GN MX</p> 	<ul style="list-style-type: none"> <li>• Premiumnagel mit ausgezeichneter Leistung auf weichem Beton</li> <li>• Wirtschaftlicher Standardnagel mit stumpfer Spitze</li> </ul>



## 2 ANWENDUNGSBEDINGUNGEN

### 2.1 Befestigungsbedingungen

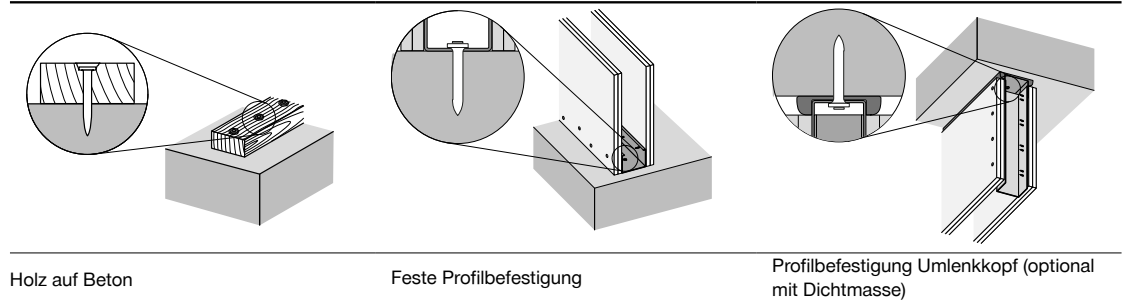

### 2.2 Untergrundmaterial

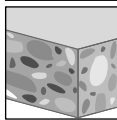

Beton

### 2.3 Lastbedingungen

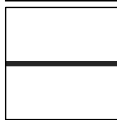

Statisch/quasi-statisch

## 2.4 Umgebungsbedingungen



Trockene Innenräume



• Weitere Einzelheiten entnehmen Sie bitte dem [Hilti Korrosionshandbuch](#).

## 3 PRODUKTDATEN

### 3.1 Abmessungen

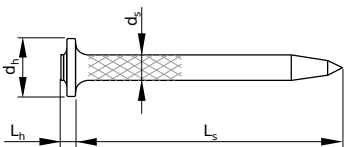
Technische Zeichnung	Befestigungselement	Kopflänge	Schaftlänge	Schaftdurchmesser	Kopfdurchmesser
		$L_h$ [mm]	$L_s$ [mm]	$d_s$ [mm]	$d_h$ [mm]
	X-C 20 B4 MX	1,8	20	3	6,5
	X-C 27 B4 MX	1,8	27	3	6,5
	X-C 32 B4 MX	1,8	32	3	6,5
	X-C 39 B4 MX	1,8	37,5	2,75	6,3
	X-C 45 B4 MX	1,8	45	2,75	6,3
	X-C 20 B3 MX	1,8	20	3	6,8
	X-C 24 B3 MX	1,9	24	3	6,5
	X-C 27 B3 MX	1,9	27	3	6,5
	X-C 30 B3 MX	1,9	30	3	6,5
	X-C 36 B3 MX	1,8	36	2,75	6,3
	X-C 20 G3 MX	1,9	19	3	6,5
	X-C 27 G3 MX	1,9	27	3	6,5
	X-C 32 G3 MX	1,9	30	3	6,5
	X-C 39 G3 MX	1,9	38,5	2,6	5,8
	X-C 20 G2 MX	1,8	19,05	2,75	6,3
	X-C 27 G2 MX	1,8	27,4	2,75	6,3
	X-C 39 G2 MX	1,9	38,5	2,6	5,8
	X-GN 20 MX	1,9	19	3	6,5
	X-GN 27 MX	1,9	27	3	6,5
	X-GN 32 MX	1,9	32	3	6,5
	X-GN 39 MX	1,9	38,5	2,6	5,8

### 3.2 Materialeigenschaften für Teile aus Kohlenstoffstahl

Befestigungselement	Bauteil	Material	Beschichtung	Beschichtungs- dicke $t_c$ [ $\mu\text{m}$ ]	Härte [HRC]	Korrosions- kategorie
X-C B4 MX	Nagel	Kohlenstoff- stahl	Verzinkt	$\geq 5$	56,5	C1
X-C B3 MX	Nagel	Kohlenstoff- stahl	Verzinkt	$\geq 5$	56,5	C1
X-C G3 MX	Nagel	Kohlenstoff- stahl	Verzinkt	$\geq 5$	56,5	C1
X-C G2 MX	Nagel	Kohlenstoff- stahl	Verzinkt	$\geq 5$	56,5	C1
X-GN 20 MX	Nagel	Kohlenstoff- stahl	Verzinkt	$\geq 5$	53,5	C1
X-GN 27 MX	Nagel	Kohlenstoff- stahl	Verzinkt	$\geq 5$	53,5	C1
X-GN 32 MX	Nagel	Kohlenstoff- stahl	Verzinkt	$\geq 5$	53,5	C1
X-GN 39 MX	Nagel	Kohlenstoff- stahl	Verzinkt	$\geq 5$	56,5	C1

• Kategorie der umgebungsbedingten Korrosivität nach EN ISO 9223.

## 4 SYSTEMEMPFEHLUNG

### 4.1 Geräteempfehlung

Befestigungsbedingung	Befestigungselement	Gerätetyp
Holz auf Beton, Feste Profilbefestigung, Profilbefestigung Umlenkkopf (optional mit Dichtmasse)	X-C B4 MX	BX 4-22 (01)
	X-C B3 MX	BX 3-ME, BX 3-IF, BX 3-ME (02), BX 3 (02), BX 3-L (02), BX 3-ME-22, BX 3-L-22, BX 3-22
	X-C G3 MX	GX 3-ME, GX 3
	X-C G2 MX	GX 2
Umlenkkopfbefestigung mit Gipsstreifen (optional mit Dichtmasse)	X-GN MX	GX 120-ME, GX 120
	X-C 45 B4 MX	BX 4-22 (01)

• Für weitere Einzelheiten wird auf das Kapitel „Kompatibilität von Zubehör und Verbrauchsmaterialien“ im [Handbuch der Direktbefestigungstechnik \(DFTM\)](#) verwiesen.

## 5 ANWENDUNGSANFORDERUNGEN

### 5.1 Eigenschaften des befestigten Materials

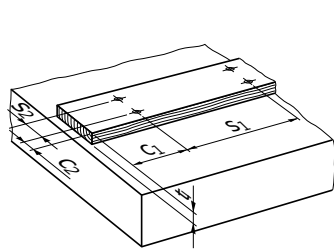

Holz auf Beton

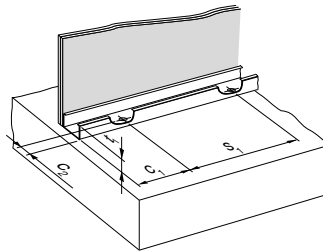

Feste Profilbefestigung

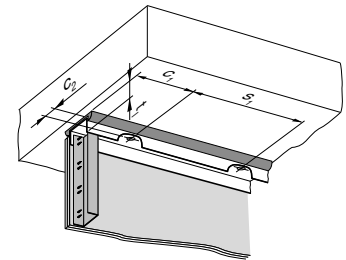

Profilbefestigung Umlenkkopf (optional mit Dichtmasse)

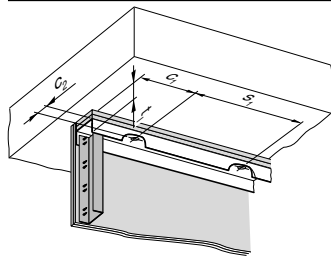

Umlenkkopfbefestigung mit Gipsstreifen (optional mit Dichtmasse)

Befestigungsbedingung	Befestigungselement	Befestigtes Material	Stärke des befestigten Materials	Randabstand	Randabstand	Abstände zwischen Befestigungselementen	Abstände zwischen Befestigungselementen
			t <sub>1</sub> [mm]	c <sub>1</sub> [mm]	c <sub>2</sub> [mm]	s <sub>1</sub> [mm]	s <sub>2</sub> [mm]
Holz auf Beton	X-C B4 MX, X-C B3 MX, X-C G3 MX, X-C G2 MX, X-GN MX	Holz	≤ 25	≥ 100	≥ 22	180 – 800	≥ 80
Feste Profilbefestigung	X-C B4 MX, X-C B3 MX, X-C G3 MX, X-C G2 MX, X-GN MX	Stahlprofil	≤ 1	≥ 40		≤ 600	≥ 80
Profilbefestigung Umlenkkopf (optional mit Dichtmasse)	X-C B4 MX, X-C B3 MX, X-C G3 MX, X-C G2 MX, X-GN MX	Stahlprofil, Hilti CSF-TTS oder Dichtmasse	≤ 3,5				
Umlenkkopfbefestigung mit Gipsstreifen (optional mit Dichtmasse)	X-C 45 B4 MX	Stahlprofil, Gipskartonplatten	≤ 33,5				

## 5.2 Eigenschaften des Untergrundmaterials

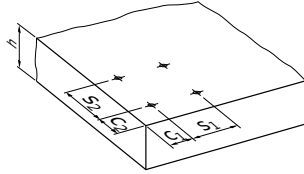

Befestigung an Beton

Untergrundmaterial	Dicke des Untergrundmaterials	Randabstand	Randabstand	Abstände zwischen Befestigungselementen	Abstände zwischen Befestigungselementen
	h [mm]	c <sub>1</sub> [mm]	c <sub>2</sub> [mm]	s <sub>1</sub> [mm]	s <sub>2</sub> [mm]
Beton	≥ 60	≥ 70	≥ 70	≥ 100	≥ 100

## 5.3 Empfehlung zur Länge von Nägeln

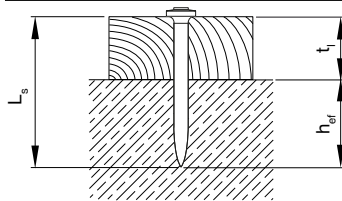

Holz auf Beton

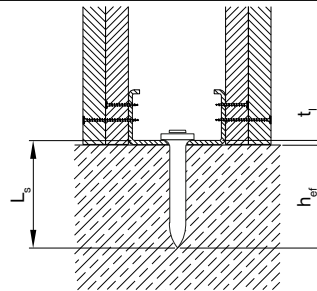

Feste Profilbefestigung

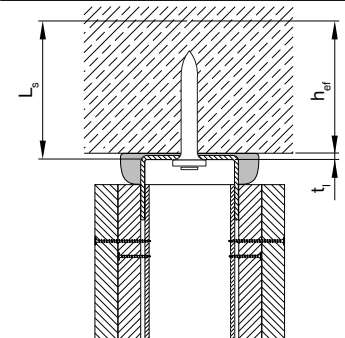

Profilbefestigung Umlenkkopf (optional mit Dichtmasse)

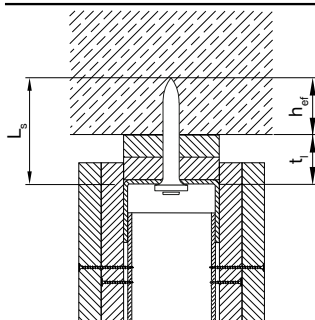

Umlenkkopfbefestigung mit Gipsstreifen (optional mit Dichtmasse)

Befestigungsbedingung	Befestigungsmerkmale	Schaftlänge	Verankerungstiefe	Stärke des befestigten Materials
		$L_s$ [mm]	$h_{ef}$ [mm]	$t_f$ [mm]
Holz auf Beton	Standardbefestigung	$L_s \geq h_{ef} + t_f$	$\geq 14$	$\leq 25$
	Bündige Befestigung	$L_s \geq h_{ef} + t_f - 3$	$\geq 14$	$\leq 25$
Feste Profilbefestigung	Standardbefestigung	$L_s \geq h_{ef} + t_f$	$\geq 14$	$\leq 1$
Profilbefestigung				
Umlenkkopf (optional mit Dichtmasse)	Standardbefestigung	$L_s \geq h_{ef} + t_f$	$\geq 14$	$\leq 3,5$
Umlenkkopfbefestigung mit Gipsstreifen (optional mit Dichtmasse)	2 Brettschichten	$L_s \geq h_{ef} + t_f$	$\geq 14$	$\leq 33,5$

## 6 LEISTUNGSDATEN

### 6.1 Empfohlene Lasten unter quasi-statischer/statischer Belastung

Befestigungsbedingung	Befestigungselement	Untergrundmaterial	Verankerungstiefe	Zuglast	Querkraft
			$h_{ef}$ [mm]	$N_{rec}$ [kN]	$V_{rec}$ [kN]
Profilbefestigung Umlenkkopf (optional mit Dichtmasse), Holz auf Beton, Feste Profilbefestigung	X-C B4 MX, X-C B3 MX, X-C G3 MX, X-C G2 MX, X-GN MX	Weicher Beton, Mittelfester Beton	14 - < 18	0,1	0,1
		Weicher Beton, Mittelfester Beton	$\geq 18$	0,2	0,2
Umlenkkopfbefestigung mit Gipsstreifen (optional mit Dichtmasse)	X-C 45 B4 MX	Weicher Beton, Mittelfester Beton	14 - < 18	0,1	0,1
		Weicher Beton, Mittelfester Beton	$\geq 18$	0,2	0,2

### 6.2 Erwartete Setzrate

Technische Zeichnung	Befestigungsbedingung	Untergrundmaterial	Erwartete Setzrate [%]
	Umlenkkopfbefestigung mit Gipsstreifen (optional mit Dichtmasse), Profilbefestigung	Weicher Beton	75-90
	Umlenkkopf (optional mit Dichtmasse), Holz auf Beton, Feste Profilbefestigung	Mittelfester Beton	75-90



- Die Setzrate kann je nach Baustellenbedingungen von den oben genannten Werten abweichen.
- Die Setzrate gibt den Anteil der Nägel an, die korrekt eingetrieben wurden, um eine Last zu tragen.

## 7 QUALITÄTSSICHERUNG

### 7.1 Befestigungskontrolle

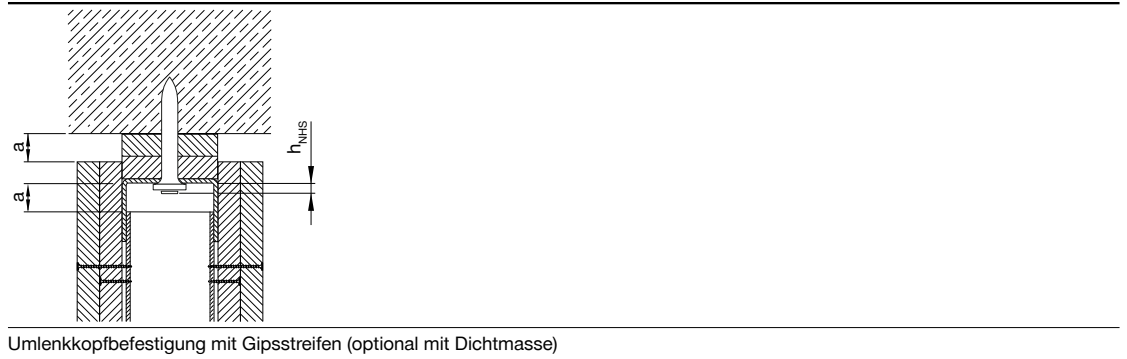
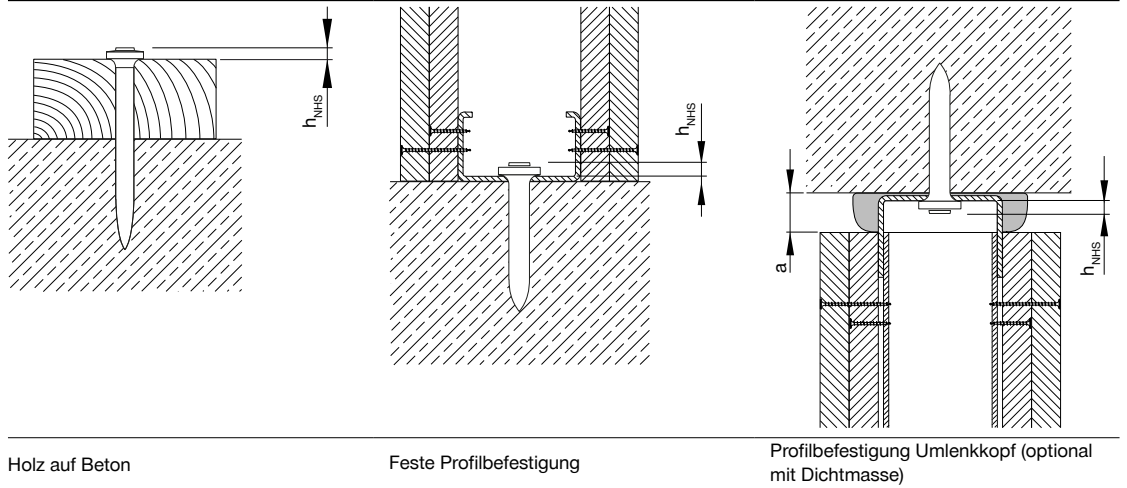

Befestigungsbedingung	Befestigungselement	Umlenkkopfspalt a [mm]	Bolzenvorstand h <sub>NHS</sub> [mm]
Holz auf Beton	X-C B4 MX, X-C B3 MX, X-C G3 MX, X-C G2 MX, X-GN MX		≤ 3
Feste Profilbefestigung	X-C B4 MX, X-C B3 MX, X-C G3 MX, X-C G2 MX, X-GN MX		2 – 5
Profilbefestigung Umlenkopf (optional mit Dichtmasse)	X-C B4 MX, X-C B3 MX, X-C G3 MX, X-C G2 MX, X-GN MX	≤ 20	2 – 3
Umlenkkopfbefestigung mit Gipsstreifen (optional mit Dichtmasse)	X-C 45 B4 MX	≤ 20	2 – 3



- Sichtbare Montagefehler sind durch ein neues Befestigungselement zu ersetzen.
- Dies ist eine gekürzte Fassung der Bedienungsanleitung. Der Wortlaut kann je nach Anwendung unterschiedlich sein.
- Beachten Sie immer die dem Produkt beiliegenden Anweisungen.

## 8 BESTELLINFORMATIONEN

### 8.1 Artikelnummer und Beschreibung

Bezeichnung	Artikelnummer	Beschreibung
X-C 20 B3 MX	2123993, 2246267	X-C B3 MX Nägel für Beton (magaziniert)
X-C 24 B3 MX	2123994, 2314526	
X-C 27 B3 MX	2224568	
X-C 30 B3 MX	2149988, 2314527	
X-C 36 B3 MX	2149989	
X-C 20 B4 MX	2361658, 2361663, 2412651, 2412652	X-C B4 MX Nägel für Beton (magaziniert)
X-C 27 B4 MX	2361659, 2361664, 2412653, 2412654	
X-C 32 B4 MX	2361660, 2361665, 2412655, 2412656	
X-C 39 B4 MX	2361661, 2361666, 2412657, 2412658	
X-C 45 B4 MX	2361662, 2361667, 2412659, 2412760	
X-C 20 G2 MX	2102013	X-C G2 MX Nägel für Beton (magaziniert)
X-C 27 G2 MX	2102014	
X-C 39 G2 MX	3539617	
X-C 20 G3 MX	2100955, 2100959	X-C G3 MX Nägel für Beton (magaziniert)
X-C 27 G3 MX	2100956, 2101040	
X-C 32 G3 MX	2100957	
X-C 39 G3 MX	2100958, 2122633	
X-GN 20 MX	2045541, 2064004, 2071406, 226933, 340232	X-GN MX Nägel für Beton (magaziniert)
X-GN 27 MX	2045540, 2064005, 2071407, 226934, 340230	
X-GN 32 MX	2045542, 2064006, 2071408, 226935, 340233	
X-GN 39 MX	2064007, 340234	





Hilti Aktiengesellschaft  
9494 Schaan, Liechtenstein  
P +423-234 2965

[www.facebook.com/hiltigroup](https://www.facebook.com/hiltigroup)  
[www.hilti.group](https://www.hilti.group)



X-C B4 MX,  
X-C B3 MX,  
X-C G3 MX,  
X-C G2 MX,  
X-GN MX

**Clous béton (en bande)**

Fiche technique

[Français](#)

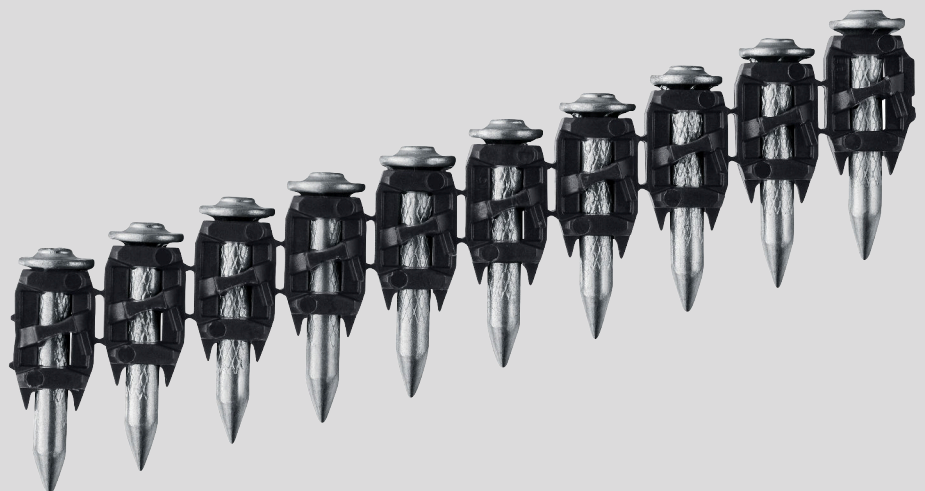





## TABLE DES MATIÈRES

<b>1</b>	<b>Informations sur le produit</b>	<b>2</b>
1.1	Description du produit	2
<b>2</b>	<b>Conditions d'application</b>	<b>3</b>
2.1	Conditions de fixation	3
2.2	Matériaux supports	3
2.3	Conditions de charge	3
2.4	Conditions environnementales	4
<b>3</b>	<b>Données produit</b>	<b>4</b>
3.1	Dimensions	4
3.2	Propriétés du matériau pour pièces en acier au carbone	5
<b>4</b>	<b>Recommandation système</b>	<b>5</b>
4.1	Recommandation sur l'outil	5
<b>5</b>	<b>Exigences en matière d'application</b>	<b>6</b>
5.1	Propriétés du matériau fixé	6
5.2	Propriétés du matériau support	7
5.3	Longueur de clou recommandée	7
<b>6</b>	<b>Données de performance</b>	<b>8</b>
6.1	Charges recommandées sous les charges quasi statiques/statiques	8
6.2	Estimation du taux de réussite	8
<b>7</b>	<b>Assurance qualité</b>	<b>9</b>
7.1	Contrôle de la fixation	9
<b>8</b>	<b>Informations de commande</b>	<b>10</b>
8.1	Numéro d'article et description	10

# 1 INFORMATIONS SUR LE PRODUIT

## 1.1 Description du produit

Désignation	Caractéristiques
<p>X-C B4 MX</p> 	<ul style="list-style-type: none"> <li>• Clou Premium pour une excellente performance dans le béton léger</li> <li>• Solution de fixation standard avec clou à pointe coupée</li> </ul>
<p>X-C B3 MX</p> 	<ul style="list-style-type: none"> <li>• Clou Premium pour une excellente performance dans le béton tendre</li> <li>• Solution de fixation standard avec clou à pointe coupée</li> </ul>
<p>X-C G3 MX</p> 	
<p>X-C G2 MX</p> 	<ul style="list-style-type: none"> <li>• Clou de haute qualité pour une excellente performance dans le béton tendre</li> <li>• Clou standard et économique avec pointe coupée</li> </ul>
<p>X-GN MX</p> 	

## 2 CONDITIONS D'APPLICATION

### 2.1 Conditions de fixation

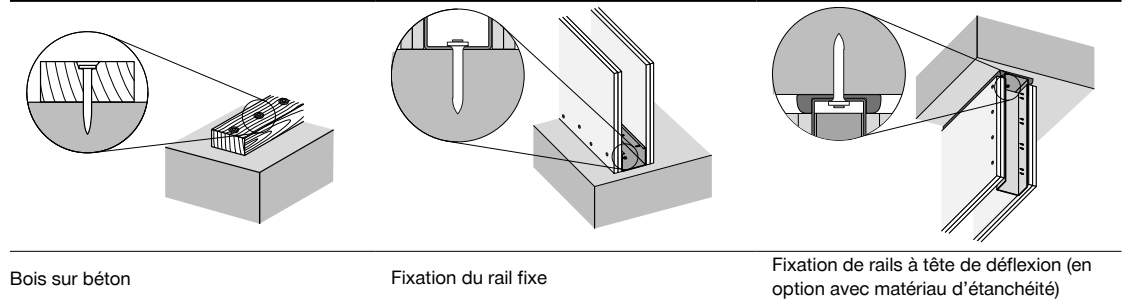

Bois sur béton

Fixation du rail fixe

Fixation de rails à tête de déflexion (en option avec matériau d'étanchéité)

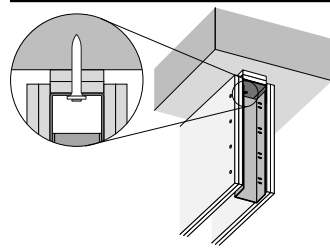

Fixation à tête de déflexion avec bandes de plâtre (en option avec matériau d'étanchéité)

### 2.2 Matériaux supports

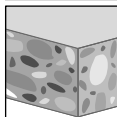

Béton

### 2.3 Conditions de charge

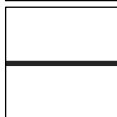

Statique/quasi statique

## 2.4 Conditions environnementales

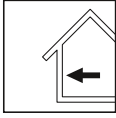

Milieu intérieur sec



• Pour de plus amples informations, veuillez vous reporter à [manuel sur la corrosion Hilti](#).

## 3 DONNÉES PRODUIT

### 3.1 Dimensions

Dessin technique	Fixation	Longueur de tête	Longueur de la tige	Diamètre de la tige	Diamètre de tête
		$L_h$ [mm]	$L_s$ [mm]	$d_s$ [mm]	$d_h$ [mm]
	X-C 20 B4 MX	1,8	20	3	6,5
	X-C 27 B4 MX	1,8	27	3	6,5
	X-C 32 B4 MX	1,8	32	3	6,5
	X-C 39 B4 MX	1,8	37,5	2,75	6,3
	X-C 45 B4 MX	1,8	45	2,75	6,3
	X-C 20 B3 MX	1,8	20	3	6,8
	X-C 24 B3 MX	1,9	24	3	6,5
	X-C 27 B3 MX	1,9	27	3	6,5
	X-C 30 B3 MX	1,9	30	3	6,5
	X-C 36 B3 MX	1,8	36	2,75	6,3
	X-C 20 G3 MX	1,9	19	3	6,5
	X-C 27 G3 MX	1,9	27	3	6,5
	X-C 32 G3 MX	1,9	30	3	6,5
	X-C 39 G3 MX	1,9	38,5	2,6	5,8
	X-C 20 G2 MX	1,8	19,05	2,75	6,3
	X-C 27 G2 MX	1,8	27,4	2,75	6,3
	X-C 39 G2 MX	1,9	38,5	2,6	5,8
	X-GN 20 MX	1,9	19	3	6,5
	X-GN 27 MX	1,9	27	3	6,5
	X-GN 32 MX	1,9	32	3	6,5
	X-GN 39 MX	1,9	38,5	2,6	5,8

## 3.2 Propriétés du matériau pour pièces en acier au carbone

Fixation	Pièce de composant	Matériau	Revêtements	Épaisseur du revêtement $t_c$ [ $\mu\text{m}$ ]	Dureté [HRC]	Catégorie de corrosivité
X-C B4 MX	Clou	Acier au carbone	Recouvert de zinc	$\geq 5$	56,5	C1
X-C B3 MX	Clou	Acier au carbone	Recouvert de zinc	$\geq 5$	56,5	C1
X-C G3 MX	Clou	Acier au carbone	Recouvert de zinc	$\geq 5$	56,5	C1
X-C G2 MX	Clou	Acier au carbone	Recouvert de zinc	$\geq 5$	56,5	C1
X-GN 20 MX	Clou	Acier au carbone	Recouvert de zinc	$\geq 5$	53,5	C1
X-GN 27 MX	Clou	Acier au carbone	Recouvert de zinc	$\geq 5$	53,5	C1
X-GN 32 MX	Clou	Acier au carbone	Recouvert de zinc	$\geq 5$	53,5	C1
X-GN 39 MX	Clou	Acier au carbone	Recouvert de zinc	$\geq 5$	56,5	C1

• Catégorie de corrosivité de l'atmosphère selon la norme EN ISO 9223.

## 4 RECOMMANDATION SYSTÈME

### 4.1 Recommandation sur l'outil

Conditions de fixation	Fixation	Type d'outil
Bois sur béton, Fixation du rail fixe, Fixation de rails à tête de déflexion (en option avec matériau d'étanchéité)	X-C B4 MX	BX 4-22 (01)
	X-C B3 MX	BX 3-ME, BX 3-IF, BX 3-ME (02), BX 3 (02), BX 3-L (02), BX 3-ME-22, BX 3-L-22, BX 3-22
	X-C G3 MX	GX 3-ME, GX 3
	X-C G2 MX	GX 2
	X-GN MX	GX 120-ME, GX 120
Fixation à tête de déflexion avec bandes de plâtre (en option avec matériau d'étanchéité)	X-C 45 B4 MX	BX 4-22 (01)

• Pour plus de détails, veuillez vous reporter au chapitre sur la compatibilité des accessoires et des consommables dans le [Guide sur la technologie de clouage \(DFTM\)](#).

## 5 EXIGENCES EN MATIÈRE D'APPLICATION

### 5.1 Propriétés du matériau fixé

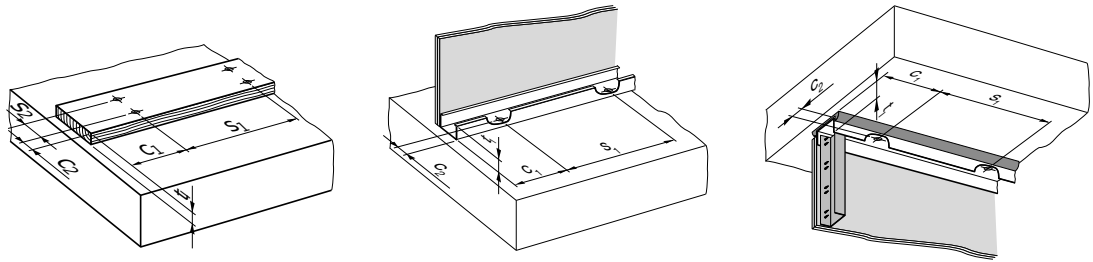

Bois sur béton

Fixation du rail fixe

Fixation de rails à tête de déflexion (en option avec matériau d'étanchéité)

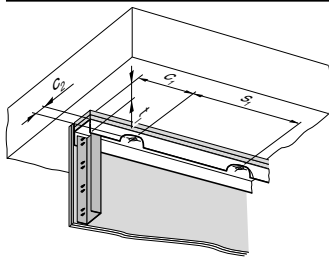

Fixation à tête de déflexion avec bandes de plâtre (en option avec matériau d'étanchéité)

Conditions de fixation	Fixation	Matériau fixé	Épaisseur du matériau fixé	Distance au bord	Distance au bord	Distance d'écartement entre les fixations	Distance d'écartement entre les fixations
			t <sub>1</sub> [mm]	c <sub>1</sub> [mm]	c <sub>2</sub> [mm]	s <sub>1</sub> [mm]	s <sub>2</sub> [mm]
Bois sur béton	X-C B4 MX, X-C B3 MX, X-C G3 MX, X-C G2 MX, X-GN MX	Bois	≤ 25	≥ 100	≥ 22	180 – 800	≥ 80
Fixation du rail fixe	X-C B4 MX, X-C B3 MX, X-C G3 MX, X-C G2 MX, X-GN MX	Rail en acier	≤ 1	≥ 40		≤ 600	≥ 80
Fixation de rails à tête de déflexion (en option avec matériau d'étanchéité)	X-C B4 MX, X-C B3 MX, X-C G3 MX, X-C G2 MX, X-GN MX	Rail en acier, Hilti CSF-TTS ou scellant	≤ 3,5				
Fixation à tête de déflexion avec bandes de plâtre (en option avec matériau d'étanchéité)	X-C 45 B4 MX	Rail en acier, plaques de plâtre	≤ 33,5				



## 5.2 Propriétés du matériau support

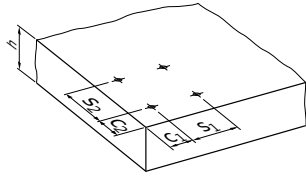

Fixation au béton

Matériau support	Épaisseur du matériau support	Distance au bord	Distance au bord	Distance d'écartement entre les fixations	Distance d'écartement entre les fixations
	h [mm]	c <sub>1</sub> [mm]	c <sub>2</sub> [mm]	s <sub>1</sub> [mm]	s <sub>2</sub> [mm]
Béton	≥ 60	≥ 70	≥ 70	≥ 100	≥ 100

## 5.3 Longueur de clou recommandée

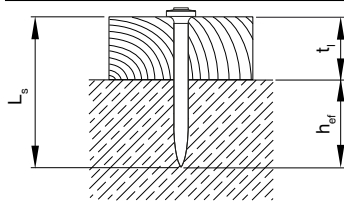

Bois sur béton

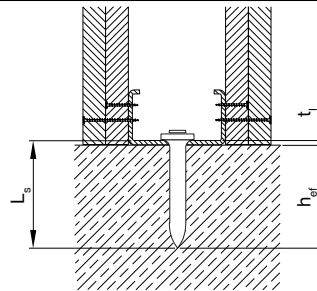

Fixation du rail fixe

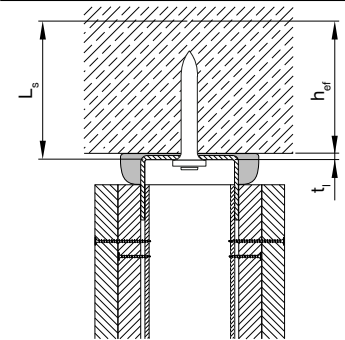

Fixation de rails à tête de déflexion (en option avec matériau d'étanchéité)

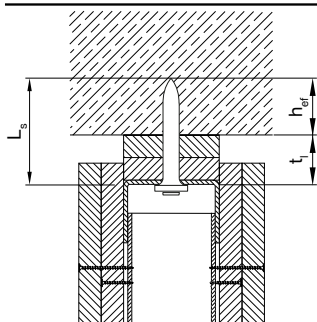

Fixation à tête de déflexion avec bandes de plâtre (en option avec matériau d'étanchéité)

Conditions de fixation	Caractéristiques de fixation	Longueur de tige	Profondeur d'implantation	Épaisseur du matériau fixé
		$L_s$ [mm]	$h_{ef}$ [mm]	$t_f$ [mm]
Bois sur béton	Fixation standard	$L_s \geq h_{ef} + t_f$	$\geq 14$	$\leq 25$
	Fixation à ras	$L_s \geq h_{ef} + t_f - 3$	$\geq 14$	$\leq 25$
Fixation du rail fixe	Fixation standard	$L_s \geq h_{ef} + t_f$	$\geq 14$	$\leq 1$
Fixation de rails à tête de déflexion (en option avec matériau d'étanchéité)	Fixation standard	$L_s \geq h_{ef} + t_f$	$\geq 14$	$\leq 3,5$
Fixation à tête de déflexion avec bandes de plâtre (en option avec matériau d'étanchéité)	2 couches de panneaux	$L_s \geq h_{ef} + t_f$	$\geq 14$	$\leq 33,5$

## 6 DONNÉES DE PERFORMANCE

### 6.1 Charges recommandées sous les charges quasi statiques/statiques

Conditions de fixation	Fixation	Type de matériau support	Profondeur d'implantation	Charge de traction	Charge de cisaillement
			$h_{ef}$ [mm]	$N_{rec}$ [kN]	$V_{rec}$ [kN]
Fixation du rail fixe, Fixation de rails à tête de déflexion (en option avec matériau d'étanchéité), Bois sur béton	X-C B4 MX, X-C B3 MX, X-C G3 MX, X-C G2 MX, X-GN MX	Béton léger, Béton moyen	14 – < 18	0,1	0,1
		Béton léger, Béton moyen	$\geq 18$	0,2	0,2
Fixation à tête de déflexion avec bandes de plâtre (en option avec matériau d'étanchéité)	X-C 45 B4 MX	Béton léger, Béton moyen	14 – < 18	0,1	0,1
		Béton léger, Béton moyen	$\geq 18$	0,2	0,2

### 6.2 Estimation du taux de réussite

Dessin technique	Conditions de fixation	Type de matériau support	Estimation du taux de réussite [%]
	Fixation du rail fixe, Fixation de rails à tête de déflexion (en option avec matériau d'étanchéité), Fixation à tête de déflexion avec bandes de plâtre (en option avec matériau d'étanchéité), Bois sur béton	Béton léger	75 – 90
		Béton moyen	75 – 90



- Le taux de réussite peut varier par rapport aux valeurs ci-dessus en fonction des conditions du chantier.
- Le taux de réussite indique le pourcentage de clous qui ont été enfoncés correctement pour porter une charge.

## 7 ASSURANCE QUALITÉ

### 7.1 Contrôle de la fixation

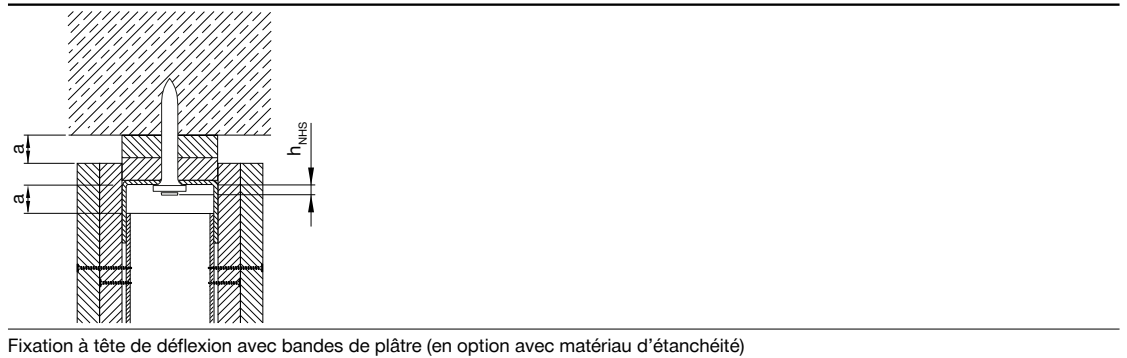
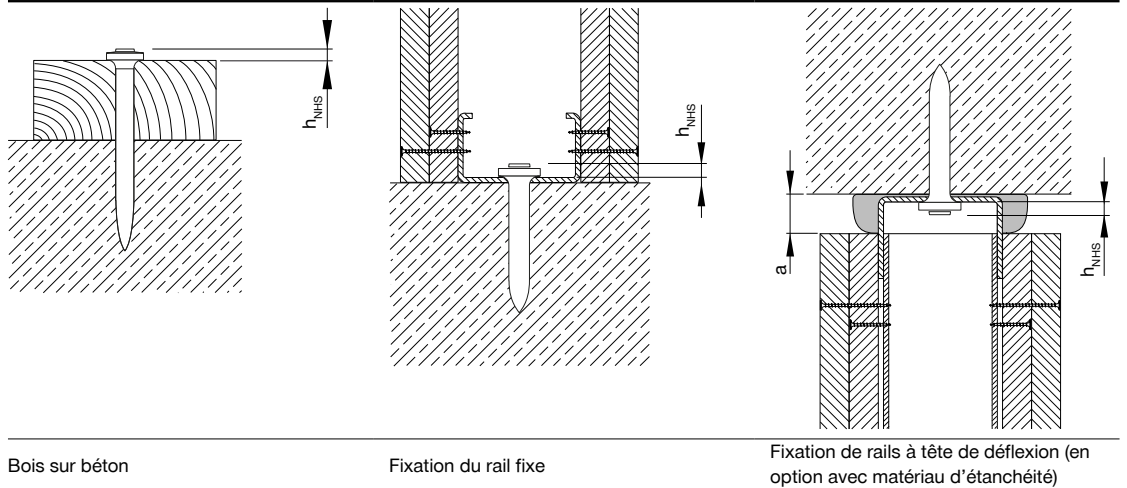

Conditions de fixation	Fixation	Écart de la tête de déflexion a [mm]	Implantation de la fixation h <sub>NHS</sub> [mm]
Bois sur béton	X-C B4 MX, X-C B3 MX, X-C G3 MX, X-C G2 MX, X-GN MX		≤3
Fixation du rail fixe	X-C B4 MX, X-C B3 MX, X-C G3 MX, X-C G2 MX, X-GN MX		2-5
Fixation de rails à tête de déflexion (en option avec matériau d'étanchéité)	X-C B4 MX, X-C B3 MX, X-C G3 MX, X-C G2 MX, X-GN MX	≤20	2-3
Fixation à tête de déflexion avec bandes de plâtre (en option avec matériau d'étanchéité)	X-C 45 B4 MX	≤20	2-3



- Les erreurs de pose visibles doivent être corrigées en réalisant une nouvelle fixation, avec un nouveau trou.
- Ces instructions abrégées peuvent varier selon l'application.
- Toujours consulter / suivre les instructions qui accompagnent le produit.

## 8 INFORMATIONS DE COMMANDE

### 8.1 Numéro d'article et description

Désignation	Code article	Description
X-C 20 B3 MX	2123993, 2246267	Clous X-C B3 MX béton (en bande)
X-C 24 B3 MX	2123994, 2314526	
X-C 27 B3 MX	2224568	
X-C 30 B3 MX	2149988, 2314527	
X-C 36 B3 MX	2149989	
X-C 20 B4 MX	2361658, 2361663, 2412651, 2412652	Clous X-C B4 MX béton (en bande)
X-C 27 B4 MX	2361659, 2361664, 2412653, 2412654	
X-C 32 B4 MX	2361660, 2361665, 2412655, 2412656	
X-C 39 B4 MX	2361661, 2361666, 2412657, 2412658	
X-C 45 B4 MX	2361662, 2361667, 2412659, 2412760	
X-C 20 G2 MX	2102013	Clous X-C G2 MX béton (en bande)
X-C 27 G2 MX	2102014	
X-C 39 G2 MX	3539617	
X-C 20 G3 MX	2100955, 2100959	Clous X-C G3 MX béton (en bande)
X-C 27 G3 MX	2100956, 2101040	
X-C 32 G3 MX	2100957	
X-C 39 G3 MX	2100958, 2122633	
X-GN 20 MX	2045541, 2064004, 2071406, 226933, 340232	Clous X-GN MX béton (en bande)
X-GN 27 MX	2045540, 2064005, 2071407, 226934, 340230	
X-GN 32 MX	2045542, 2064006, 2071408, 226935, 340233	
X-GN 39 MX	2064007, 340234	



Hilti Aktiengesellschaft  
9494 Schaan, Liechtenstein  
P +423-234 2965

[www.facebook.com/hiltigroup](https://www.facebook.com/hiltigroup)  
[www.hilti.group](https://www.hilti.group)



X-C B4 MX,  
X-C B3 MX,  
X-C G3 MX,  
X-C G2 MX,  
X-GN MX

**Clavos para hormigón (en tiras)**

Hoja de datos

[Español](#)

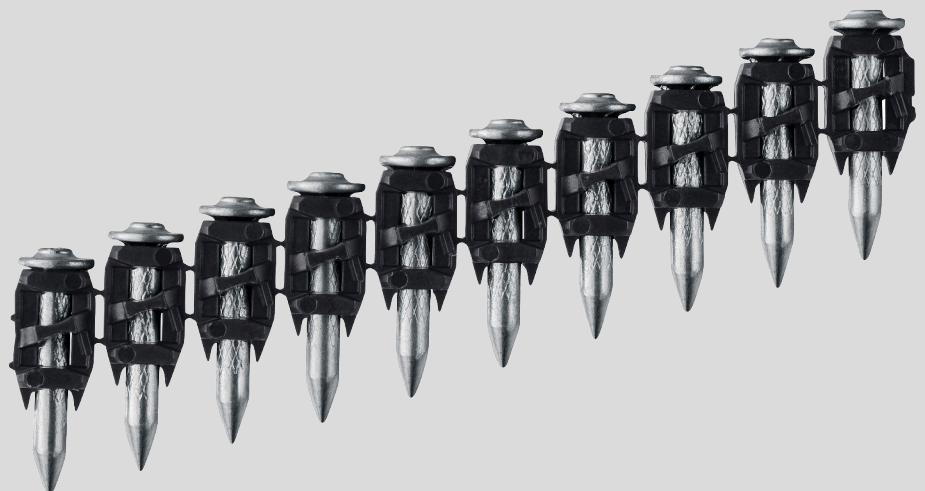





## ÍNDICE

<b>1</b>	<b>Información del producto</b>	<b>2</b>
1.1	Descripción del producto	2
<b>2</b>	<b>Condiciones de aplicación</b>	<b>3</b>
2.1	Condiciones de fijación	3
2.2	Materiales base	3
2.3	Condiciones de carga	3
2.4	Condiciones ambientales	4
<b>3</b>	<b>Datos del producto</b>	<b>4</b>
3.1	Dimensiones	4
3.2	Propiedades del material para piezas de acero al carbono	5
<b>4</b>	<b>Recomendación del sistema</b>	<b>5</b>
4.1	Recomendación de herramienta	5
<b>5</b>	<b>Requisitos de aplicación</b>	<b>6</b>
5.1	Propiedades del material de fijación	6
5.2	Propiedades del material base	7
5.3	Recomendación de longitud de clavo	7
<b>6</b>	<b>Datos de rendimiento</b>	<b>8</b>
6.1	Cargas recomendadas con carga estática/cuasiestática	8
6.2	Estimación de ratio de fijación correcta	8
<b>7</b>	<b>Control de calidad</b>	<b>9</b>
7.1	Inspección de fijación	9
<b>8</b>	<b>Información del pedido</b>	<b>10</b>
8.1	Número y descripción del artículo	10

# 1 INFORMACIÓN DEL PRODUCTO

## 1.1 Descripción del producto

Designación	Características
X-C B4 MX	 <ul style="list-style-type: none"><li>• Clavo de alta calidad que ofrece un excelente rendimiento en hormigón blando</li><li>• Solución de fijación diaria con clavo de punta cortada</li></ul>
X-C B3 MX	
X-C G3 MX	
X-C G2 MX	
X-GN MX	



## 2 CONDICIONES DE APLICACIÓN

### 2.1 Condiciones de fijación

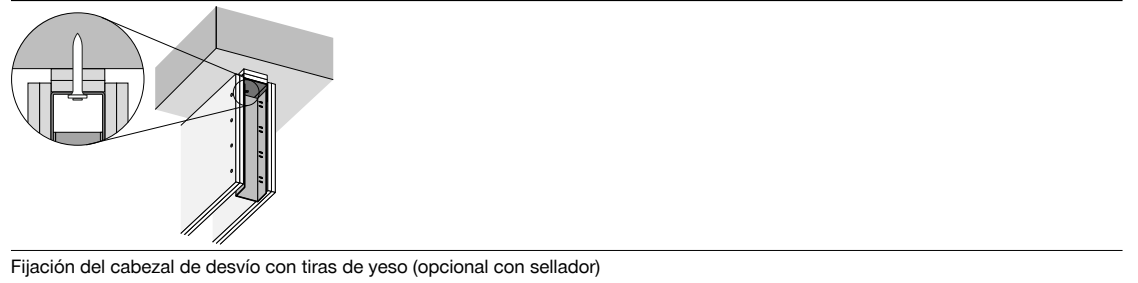
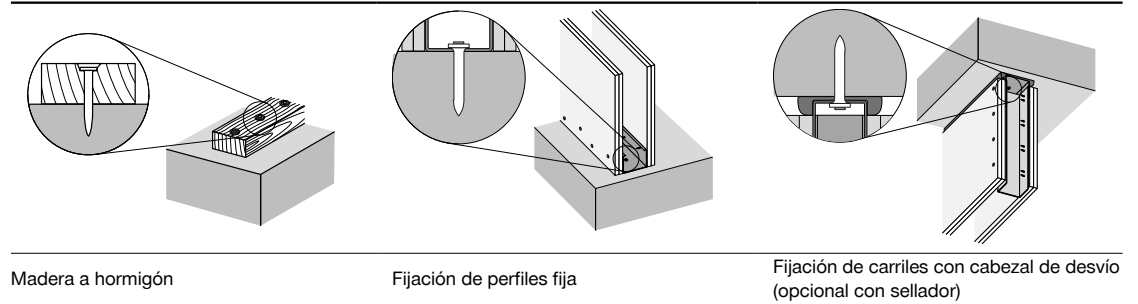

### 2.2 Materiales base

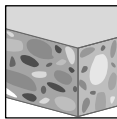

Hormigón

### 2.3 Condiciones de carga

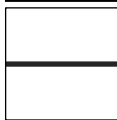

Estática y cuasiestática

## 2.4 Condiciones ambientales

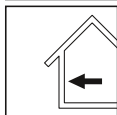

Interior seco



• Para obtener más información, consulte [Manual de corrosión de Hilti](#).

## 3 DATOS DEL PRODUCTO

### 3.1 Dimensiones

Dibujo técnico	Fijación	Longitud de cabeza	Longitud del vástago	Diámetro de vástago	Diámetro de la cabeza
		$L_h$ [mm]	$L_s$ [mm]	$d_s$ [mm]	$d_h$ [mm]
	X-C 20 B4 MX	1,8	20	3	6,5
	X-C 27 B4 MX	1,8	27	3	6,5
	X-C 32 B4 MX	1,8	32	3	6,5
	X-C 39 B4 MX	1,8	37,5	2,75	6,3
	X-C 45 B4 MX	1,8	45	2,75	6,3
	X-C 20 B3 MX	1,8	20	3	6,8
	X-C 24 B3 MX	1,9	24	3	6,5
	X-C 27 B3 MX	1,9	27	3	6,5
	X-C 30 B3 MX	1,9	30	3	6,5
	X-C 36 B3 MX	1,8	36	2,75	6,3
	X-C 20 G3 MX	1,9	19	3	6,5
	X-C 27 G3 MX	1,9	27	3	6,5
	X-C 32 G3 MX	1,9	30	3	6,5
	X-C 39 G3 MX	1,9	38,5	2,6	5,8
	X-C 20 G2 MX	1,8	19,05	2,75	6,3
	X-C 27 G2 MX	1,8	27,4	2,75	6,3
	X-C 39 G2 MX	1,9	38,5	2,6	5,8
	X-GN 20 MX	1,9	19	3	6,5
	X-GN 27 MX	1,9	27	3	6,5
	X-GN 32 MX	1,9	32	3	6,5
X-GN 39 MX	1,9	38,5	2,6	5,8	

## 3.2 Propiedades del material para piezas de acero al carbono

Fijación	Pieza de componente	Material	Revestimiento	Espesor del revestimiento $t_c$ [ $\mu\text{m}$ ]	Dureza [HRC]	Categoría de corrosión
X-C B4 MX	Clavo	Acero al carbono	Con revestimiento de zinc	$\geq 5$	56,5	C1
X-C B3 MX	Clavo	Acero al carbono	Con revestimiento de zinc	$\geq 5$	56,5	C1
X-C G3 MX	Clavo	Acero al carbono	Con revestimiento de zinc	$\geq 5$	56,5	C1
X-C G2 MX	Clavo	Acero al carbono	Con revestimiento de zinc	$\geq 5$	56,5	C1
X-GN 20 MX	Clavo	Acero al carbono	Con revestimiento de zinc	$\geq 5$	53,5	C1
X-GN 27 MX	Clavo	Acero al carbono	Con revestimiento de zinc	$\geq 5$	53,5	C1
X-GN 32 MX	Clavo	Acero al carbono	Con revestimiento de zinc	$\geq 5$	53,5	C1
X-GN 39 MX	Clavo	Acero al carbono	Con revestimiento de zinc	$\geq 5$	56,5	C1

• Categoría de corrosión de la atmósfera según la norma EN ISO 9223.

## 4 RECOMENDACIÓN DEL SISTEMA

### 4.1 Recomendación de herramienta

Condición de fijación	Fijación	Tipo de herramienta
Madera a hormigón, Fijación de perfiles fija, Fijación de carriles con cabezal de desvío (opcional con sellador)	X-C B4 MX	BX 4-22 (01)
	X-C B3 MX	BX 3-ME, BX 3-IF, BX 3-ME (02), BX 3 (02), BX 3-L (02), BX 3-ME-22, BX 3-L-22, BX 3-22
	X-C G3 MX	GX 3-ME, GX 3
	X-C G2 MX	GX 2
	X-GN MX	GX 120-ME, GX 120
Fijación del cabezal de desvío con tiras de yeso (opcional con sellador)	X-C 45 B4 MX	BX 4-22 (01)

• Para obtener más detalles, consulte el capítulo sobre la compatibilidad de accesorios y consumibles en el [Manual de tecnología de fijación directa \(DFTM\)](#).

## 5 REQUISITOS DE APLICACIÓN

### 5.1 Propiedades del material de fijación

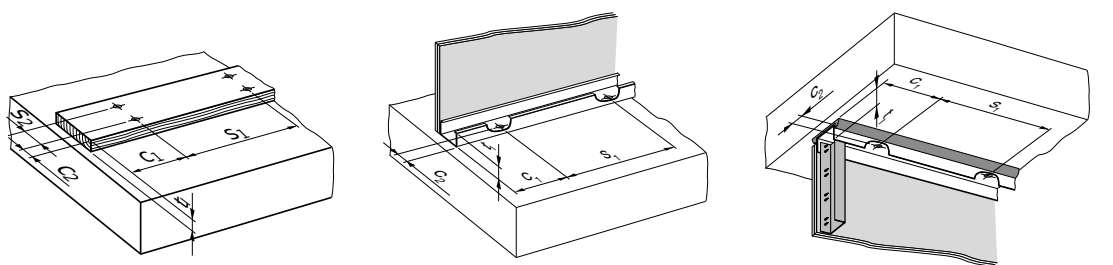

Madera a hormigón

Fijación de perfiles fija

Fijación de carriles con cabezal de desvío (opcional con sellador)

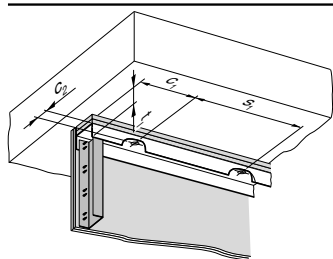

Fijación del cabezal de desvío con tiras de yeso (opcional con sellador)

Condición de fijación	Fijación	Material de fijación	Esesor del material fijado	Distancia al borde	Distancia al borde	Distancia de separación de la fijación	Distancia de separación de la fijación
			t <sub>1</sub> [mm]	c <sub>1</sub> [mm]	c <sub>2</sub> [mm]	s <sub>1</sub> [mm]	s <sub>2</sub> [mm]
Madera a hormigón	X-C B4 MX, X-C B3 MX, X-C G3 MX, X-C G2 MX, X-GN MX	Madera	≤ 25	≥ 100	≥ 22	180 – 800	≥ 80
Fijación de perfiles fija	X-C B4 MX, X-C B3 MX, X-C G3 MX, X-C G2 MX, X-GN MX	Carril de acero	≤ 1	≥ 40		≤ 600	≥ 80
Fijación de carriles con cabezal de desvío (opcional con sellador)	X-C B4 MX, X-C B3 MX, X-C G3 MX, X-C G2 MX, X-GN MX	Carril de acero, Hilti CSF-TTS o sellador	≤ 3,5				
Fijación del cabezal de desvío con tiras de yeso (opcional con sellador)	X-C 45 B4 MX	Carril de acero, placa de yeso	≤ 33,5				

## 5.2 Propiedades del material base

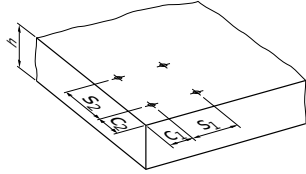

Fijación a hormigón

Material base	Espesor del material base	Distancia al borde	Distancia al borde	Distancia de separación de la fijación	Distancia de separación de la fijación
	h [mm]	c <sub>1</sub> [mm]	c <sub>2</sub> [mm]	s <sub>1</sub> [mm]	s <sub>2</sub> [mm]
Hormigón	≥ 60	≥ 70	≥ 70	≥ 100	≥ 100

## 5.3 Recomendación de longitud de clavo

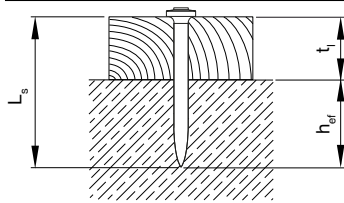

Madera a hormigón

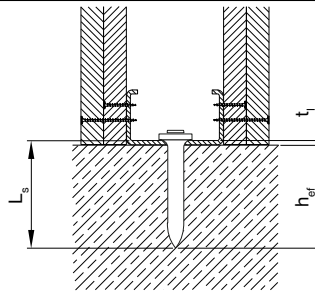

Fijación de perfiles fija

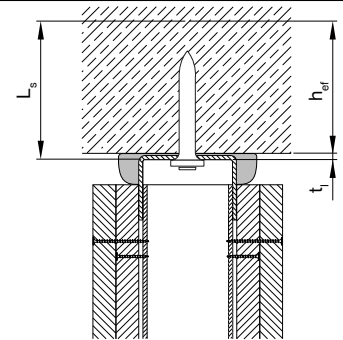

Fijación de carriles con cabezal de desvío (opcional con sellador)

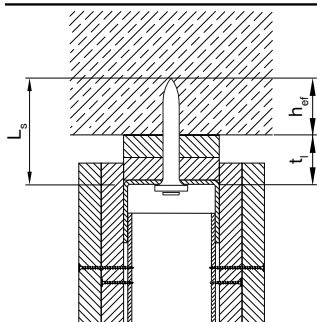

Fijación del cabezal de desvío con tiras de yeso (opcional con sellador)

Condición de fijación	Características de fijación	Longitud del vástago	Profundidad de empotramiento	Espesor del material fijado
		$L_s$ [mm]	$h_{ef}$ [mm]	$t_f$ [mm]
Madera a hormigón	Fijación estándar	$L_s \geq h_{ef} + t_f$	$\geq 14$	$\leq 25$
	Fijación a ras	$L_s \geq h_{ef} + t_f - 3$	$\geq 14$	$\leq 25$
Fijación de perfiles fija	Fijación estándar	$L_s \geq h_{ef} + t_f$	$\geq 14$	$\leq 1$
Fijación de carriles con cabezal de desvío (opcional con sellador)	Fijación estándar	$L_s \geq h_{ef} + t_f$	$\geq 14$	$\leq 3,5$
Fijación del cabezal de desvío con tiras de yeso (opcional con sellador)	2 capas de tablero	$L_s \geq h_{ef} + t_f$	$\geq 14$	$\leq 33,5$

## 6 DATOS DE RENDIMIENTO

### 6.1 Cargas recomendadas con carga estática/cuasiestática

Condición de fijación	Fijación	Tipo de material base	Profundidad de empotramiento	Carga de tensión	Carga cortante
			$h_{ef}$ [mm]	$N_{rec}$ [kN]	$V_{rec}$ [kN]
Madera a hormigón, Fijación de perfiles fija, Fijación de carriles con cabezal de desvío (opcional con sellador)	X-C B4 MX, X-C B3 MX, X-C G3 MX, X-C G2 MX, X-GN MX	Hormigón blando, Hormigón medio	14 - < 18	0,1	0,1
		Hormigón blando, Hormigón medio	$\geq 18$	0,2	0,2
Fijación del cabezal de desvío con tiras de yeso (opcional con sellador)	X-C 45 B4 MX	Hormigón blando, Hormigón medio	14 - < 18	0,1	0,1
		Hormigón blando, Hormigón medio	$\geq 18$	0,2	0,2

### 6.2 Estimación de ratio de fijación correcta

Dibujo técnico	Condición de fijación	Tipo de material base	Estimación de ratio de fijación correcta [ % ]
	Madera a hormigón, Fijación del cabezal de desvío con tiras de yeso (opcional con sellador), Fijación de perfiles fija, Fijación de carriles con cabezal de desvío (opcional con sellador)	Hormigón blando	75 - 90
		Hormigón medio	75 - 90



- El ratio de fijación correcta puede variar de los valores anteriores en función de las condiciones del lugar de trabajo.
- La tasa de fijación indica el porcentaje de clavos que se colocaron correctamente para soportar una carga.

## 7 CONTROL DE CALIDAD

### 7.1 Inspección de fijación

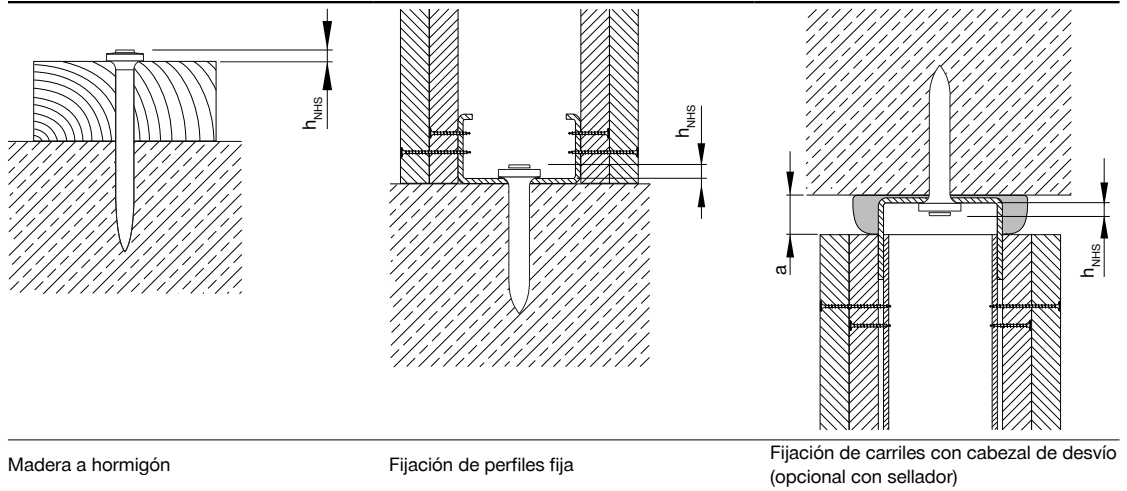

Madera a hormigón

Fijación de perfiles fija

Fijación de carriles con cabezal de desvío (opcional con sellador)

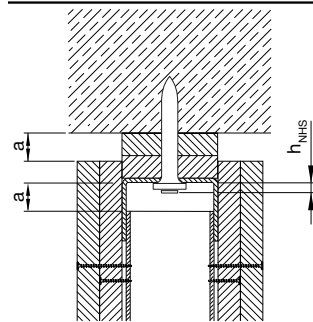

Fijación del cabezal de desvío con tiras de yeso (opcional con sellador)

Condición de fijación	Fijación	Separación del cabezal de desvío	Fijación con distanciador
		a [mm]	$h_{NHS}$ [mm]
Madera a hormigón	X-C B4 MX, X-C B3 MX, X-C G3 MX, X-C G2 MX, X-GN MX		≤3
Fijación de perfiles fija	X-C B4 MX, X-C B3 MX, X-C G3 MX, X-C G2 MX, X-GN MX		2-5
Fijación de carriles con cabezal de desvío (opcional con sellador)	X-C B4 MX, X-C B3 MX, X-C G3 MX, X-C G2 MX, X-GN MX	≤20	2-3
Fijación del cabezal de desvío con tiras de yeso (opcional con sellador)	X-C 45 B4 MX	≤20	2-3



- Los fallos de colocación visibles deben sustituirse por nuevas fijaciones, sin utilizar el mismo orificio.
- Estas instrucciones se encuentran abreviadas y pueden variar según la aplicación.
- Revise y siga siempre las instrucciones que acompañan al producto.

## 8 INFORMACIÓN DEL PEDIDO

### 8.1 Número y descripción del artículo

Designación	Número de elemento	Descripción
X-C 20 B3 MX	2123993, 2246267	Clavos para hormigón X-C B3 MX (en tiras)
X-C 24 B3 MX	2123994, 2314526	
X-C 27 B3 MX	2224568	
X-C 30 B3 MX	2149988, 2314527	
X-C 36 B3 MX	2149989	
X-C 20 B4 MX	2361658, 2361663, 2412651, 2412652	Clavos para hormigón X-C B4 MX (en tiras)
X-C 27 B4 MX	2361659, 2361664, 2412653, 2412654	
X-C 32 B4 MX	2361660, 2361665, 2412655, 2412656	
X-C 39 B4 MX	2361661, 2361666, 2412657, 2412658	
X-C 45 B4 MX	2361662, 2361667, 2412659, 2412760	
X-C 20 G2 MX	2102013	Clavos para hormigón X-C G2 MX (en tiras)
X-C 27 G2 MX	2102014	
X-C 39 G2 MX	3539617	
X-C 20 G3 MX	2100955, 2100959	Clavos para hormigón X-C G3 MX (en tiras)
X-C 27 G3 MX	2100956, 2101040	
X-C 32 G3 MX	2100957	
X-C 39 G3 MX	2100958, 2122633	
X-GN 20 MX	2045541, 2064004, 2071406, 226933, 340232	Clavos para hormigón X-GN MX (en tiras)
X-GN 27 MX	2045540, 2064005, 2071407, 226934, 340230	
X-GN 32 MX	2045542, 2064006, 2071408, 226935, 340233	
X-GN 39 MX	2064007, 340234	





Hilti Aktiengesellschaft  
9494 Schaan, Liechtenstein  
P +423-234 2965

[www.facebook.com/hiltigroup](https://www.facebook.com/hiltigroup)  
[www.hilti.group](https://www.hilti.group)



X-C B4 MX,  
X-C B3 MX,  
X-C G3 MX,  
X-C G2 MX,  
X-GN MX

**Chiodi per calcestruzzo (a nastro)**

Scheda tecnica

[Italiano](#)

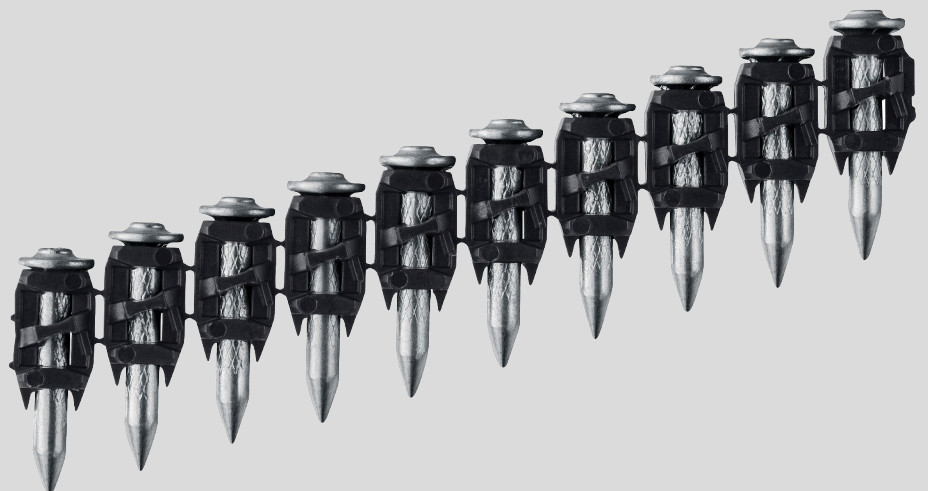





## INDICE

<b>1</b>	<b>Informazioni sul prodotto</b>	<b>2</b>
1.1	Descrizione del prodotto	2
<b>2</b>	<b>Condizioni di applicazione</b>	<b>3</b>
2.1	Condizioni di fissaggio	3
2.2	Materiali di base	3
2.3	Condizioni di carico	3
2.4	Condizioni ambientali	4
<b>3</b>	<b>Dati del prodotto</b>	<b>4</b>
3.1	Dimensioni	4
3.2	Proprietà dei materiali per parti in acciaio al carbonio	5
<b>4</b>	<b>Raccomandazioni sul sistema</b>	<b>5</b>
4.1	Raccomandazioni per l'attrezzo	5
<b>5</b>	<b>Requisiti di applicazione</b>	<b>6</b>
5.1	Caratteristiche del materiale fissato	6
5.2	Proprietà del materiale di base	7
5.3	Lunghezza del chiodo consigliata	7
<b>6</b>	<b>Dati sulle prestazioni</b>	<b>8</b>
6.1	Carichi raccomandati in caso carico statico/quasi statico	8
6.2	Stima del tasso di trucioli	8
<b>7</b>	<b>Assicurazione qualità</b>	<b>9</b>
7.1	Ispezione fissaggio	9
<b>8</b>	<b>Informazioni per l'ordine</b>	<b>10</b>
8.1	Numero articolo e descrizione	10

# 1 INFORMAZIONI SUL PRODOTTO

## 1.1 Descrizione del prodotto

Denominazione	Vantaggi
<p>X-C B4 MX</p> 	<ul style="list-style-type: none"> <li>• Chiodo premium per prestazioni eccellenti sul calcestruzzo morbido</li> <li>• Soluzione di fissaggio quotidiana con chiodo a punta tagliata</li> </ul>
<p>X-C B3 MX</p> 	<ul style="list-style-type: none"> <li>• Chiodo premium per prestazioni eccellenti sul calcestruzzo morbido</li> <li>• Chiodo standard economico con punta da taglio</li> </ul>
<p>X-C G3 MX</p> 	<ul style="list-style-type: none"> <li>• Chiodo premium per prestazioni eccellenti sul calcestruzzo morbido</li> <li>• Soluzione di fissaggio quotidiana con chiodo a punta tagliata</li> </ul>
<p>X-C G2 MX</p> 	<ul style="list-style-type: none"> <li>• Chiodo premium per prestazioni eccellenti sul calcestruzzo morbido</li> <li>• Soluzione di fissaggio quotidiana con chiodo a punta tagliata</li> </ul>
<p>X-GN MX</p> 	<ul style="list-style-type: none"> <li>• Chiodo premium per prestazioni eccellenti sul calcestruzzo morbido</li> <li>• Chiodo standard economico con punta da taglio</li> </ul>

## 2 CONDIZIONI DI APPLICAZIONE

### 2.1 Condizioni di fissaggio

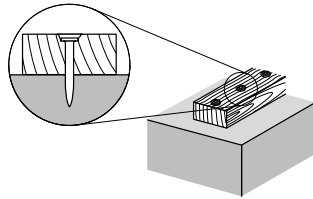

Legno su calcestruzzo

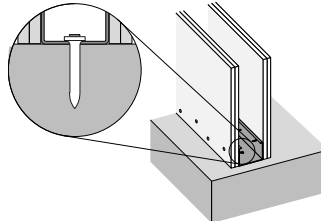

Fissaggio guida fissa

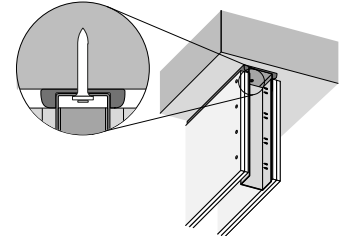

Fissaggio del binario della testa di deviazione (in via opzionale con sigillante)

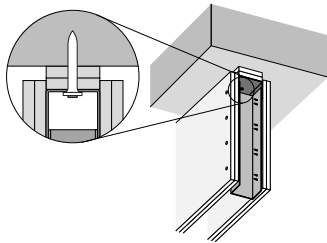

Fissaggio della testa di deviazione con strisce di gesso (opzionale con sigillante)

### 2.2 Materiali di base

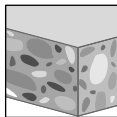

Calcestruzzo

### 2.3 Condizioni di carico

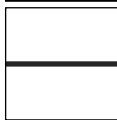

Statico/quasi statico

## 2.4 Condizioni ambientali

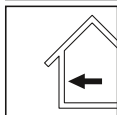

Interni asciutti



• Per maggiori dettagli, fare riferimento a [Hilti Corrosion Handbook](#) (Manuale sulla corrosione Hilti).

## 3 DATI DEL PRODOTTO

### 3.1 Dimensioni

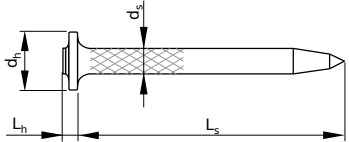
Disegno tecnico	Elemento di fissaggio	Lunghezza testa	Lunghezza gambo	Diametro gambo	Diametro testa
		$L_h$ [mm]	$L_s$ [mm]	$d_s$ [mm]	$d_h$ [mm]
	X-C 20 B4 MX	1,8	20	3	6,5
	X-C 27 B4 MX	1,8	27	3	6,5
	X-C 32 B4 MX	1,8	32	3	6,5
	X-C 39 B4 MX	1,8	37,5	2,75	6,3
	X-C 45 B4 MX	1,8	45	2,75	6,3
	X-C 20 B3 MX	1,8	20	3	6,8
	X-C 24 B3 MX	1,9	24	3	6,5
	X-C 27 B3 MX	1,9	27	3	6,5
	X-C 30 B3 MX	1,9	30	3	6,5
	X-C 36 B3 MX	1,8	36	2,75	6,3
	X-C 20 G3 MX	1,9	19	3	6,5
	X-C 27 G3 MX	1,9	27	3	6,5
	X-C 32 G3 MX	1,9	30	3	6,5
	X-C 39 G3 MX	1,9	38,5	2,6	5,8
	X-C 20 G2 MX	1,8	19,05	2,75	6,3
	X-C 27 G2 MX	1,8	27,4	2,75	6,3
	X-C 39 G2 MX	1,9	38,5	2,6	5,8
	X-GN 20 MX	1,9	19	3	6,5
	X-GN 27 MX	1,9	27	3	6,5
	X-GN 32 MX	1,9	32	3	6,5
	X-GN 39 MX	1,9	38,5	2,6	5,8

## 3.2 Proprietà dei materiali per parti in acciaio al carbonio

Elemento di fissaggio	Parte del componente	Materiale	Rivestimento	Spessore di rivestimento $t_c$ [ $\mu\text{m}$ ]	Durezza [HRC]	Categoria di corrosività
X-C B4 MX	Chiodo	Acciaio al carbonio	Zincato	$\geq 5$	56,5	C1
X-C B3 MX	Chiodo	Acciaio al carbonio	Zincato	$\geq 5$	56,5	C1
X-C G3 MX	Chiodo	Acciaio al carbonio	Zincato	$\geq 5$	56,5	C1
X-C G2 MX	Chiodo	Acciaio al carbonio	Zincato	$\geq 5$	56,5	C1
X-GN 20 MX	Chiodo	Acciaio al carbonio	Zincato	$\geq 5$	53,5	C1
X-GN 27 MX	Chiodo	Acciaio al carbonio	Zincato	$\geq 5$	53,5	C1
X-GN 32 MX	Chiodo	Acciaio al carbonio	Zincato	$\geq 5$	53,5	C1
X-GN 39 MX	Chiodo	Acciaio al carbonio	Zincato	$\geq 5$	56,5	C1

• Categoria di corrosività dell'atmosfera secondo EN ISO 9223.

## 4 RACCOMANDAZIONI SUL SISTEMA

### 4.1 Raccomandazioni per l'attrezzo

Condizione di fissaggio	Elemento di fissaggio	Tipo di attrezzo
Legno su calcestruzzo, Fissaggio guida fissa, Fissaggio del binario della testa di deviazione (in via opzionale con sigillante)	X-C B4 MX	BX 4-22 (01)
	X-C B3 MX	BX 3-ME, BX 3-IF, BX 3-ME (02), BX 3 (02), BX 3-L (02), BX 3-ME-22, BX 3-L-22, BX 3-22
	X-C G3 MX	GX 3-ME, GX 3
	X-C G2 MX	GX 2
	X-GN MX	GX 120-ME, GX 120
Fissaggio della testa di deviazione con strisce di gesso (opzionale con sigillante)	X-C 45 B4 MX	BX 4-22 (01)

• Per maggiori dettagli, fare riferimento al capitolo Compatibilità di accessori e materiali di consumo all'indirizzo [Direct Fastening Technology Manual \(DFTM\)](#) (Manuale del fissaggio diretto).

## 5 REQUISITI DI APPLICAZIONE

### 5.1 Caratteristiche del materiale fissato

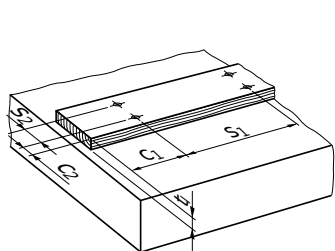

Legno su calcestruzzo

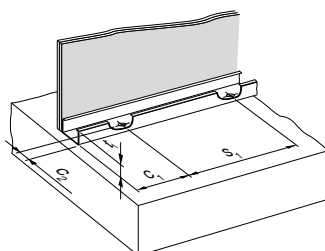

Fissaggio guida fissa

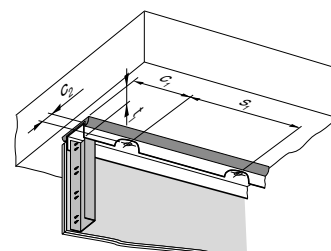

Fissaggio del binario della testa di deviazione (in via opzionale con sigillante)

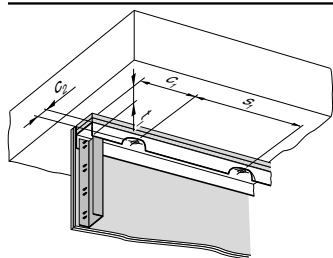

Fissaggio della testa di deviazione con strisce di gesso (opzionale con sigillante)

Condizione di fissaggio	Elemento di fissaggio	Materiale fissato	Spessore materiale fissato	Distanza dal bordo	Distanza dal bordo	Distanza dall'elemento di fissaggio	Distanza dall'elemento di fissaggio
			t <sub>1</sub> [mm]	c <sub>1</sub> [mm]	c <sub>2</sub> [mm]	s <sub>1</sub> [mm]	s <sub>2</sub> [mm]
Legno su calcestruzzo	X-C B4 MX, X-C B3 MX, X-C G3 MX, X-C G2 MX, X-GN MX	Legno	≤ 25	≥ 100	≥ 22	180 - 800	≥ 80
Fissaggio guida fissa	X-C B4 MX, X-C B3 MX, X-C G3 MX, X-C G2 MX, X-GN MX	Binari d'acciaio	≤ 1	≥ 40		≤ 600	≥ 80
Fissaggio del binario della testa di deviazione (in via opzionale con sigillante)	X-C B4 MX, X-C B3 MX, X-C G3 MX, X-C G2 MX, X-GN MX	Pannelli d'acciaio, Hilti CSF-TTS o sigillante	≤ 3,5				
Fissaggio della testa di deviazione con strisce di gesso (opzionale con sigillante)	X-C 45 B4 MX	Binari d'acciaio, pannelli in cartongesso	≤ 33,5				



## 5.2 Proprietà del materiale di base

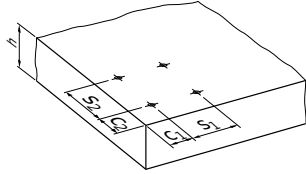

Fissaggio su calcestruzzo

Materiale di base	Spessore materiale di base	Distanza dal bordo	Distanza dal bordo	Distanza dall'elemento di fissaggio	Distanza dall'elemento di fissaggio
	$h$ [mm]	$c_1$ [mm]	$c_2$ [mm]	$s_1$ [mm]	$s_2$ [mm]
Calcestruzzo	$\geq 60$	$\geq 70$	$\geq 70$	$\geq 100$	$\geq 100$

## 5.3 Lunghezza del chiodo consigliata

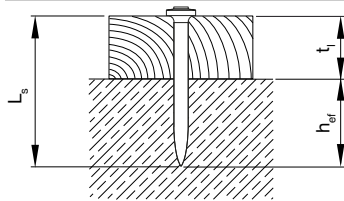

Legno su calcestruzzo

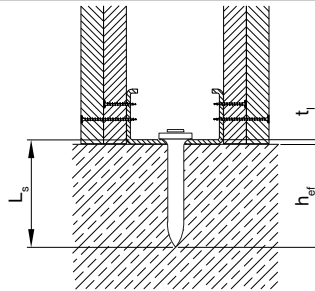

Fissaggio guida fissa

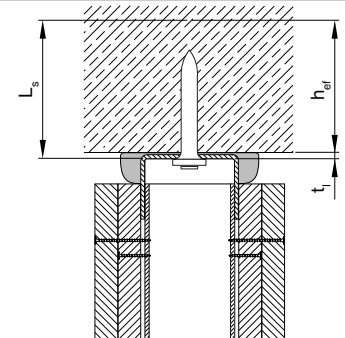

Fissaggio del binario della testa di deviazione (in via opzionale con sigillante)

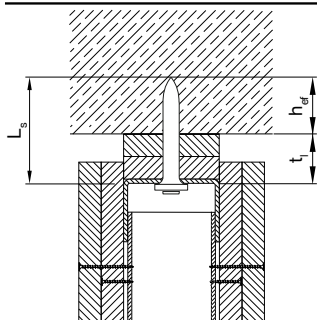

Fissaggio della testa di deviazione con strisce di gesso (opzionale con sigillante)

Condizione di fissaggio	Caratteristiche di fissaggio	Lunghezza gambo	Profondità di posa	Spessore materiale fissato
		$L_s$ [mm]	$h_{ef}$ [mm]	$t_f$ [mm]
Legno su calcestruzzo	Fissazione standard	$L_s \geq h_{ef} + t_f$	$\geq 14$	$\leq 25$
	Fissaggio a filo	$L_s \geq h_{ef} + t_f - 3$	$\geq 14$	$\leq 25$
Fissaggio guida fissa	Fissazione standard	$L_s \geq h_{ef} + t_f$	$\geq 14$	$\leq 1$
Fissaggio del binario della testa di deviazione (in via opzionale con sigillante)	Fissazione standard	$L_s \geq h_{ef} + t_f$	$\geq 14$	$\leq 3,5$
Fissaggio della testa di deviazione con strisce di gesso (opzionale con sigillante)	2 strati del pannello	$L_s \geq h_{ef} + t_f$	$\geq 14$	$\leq 33,5$

## 6 DATI SULLE PRESTAZIONI

### 6.1 Carichi raccomandati in caso carico statico/quasi statico

Condizione di fissaggio	Elemento di fissaggio	Tipo di materiale base	Profondità di posa	Carico a trazione	Carico di taglio
			$h_{ef}$ [mm]	$N_{rec}$ [kN]	$V_{rec}$ [kN]
Legno su calcestruzzo, Fissaggio guida fissa, Fissaggio del binario della testa di deviazione (in via opzionale con sigillante)	X-C B4 MX, X-C B3 MX, X-C G3 MX, X-C G2 MX, X-GN MX	Cemento morbido, Calcestruzzo medio	14 - < 18	0,1	0,1
		Cemento morbido, Calcestruzzo medio	$\geq 18$	0,2	0,2
Fissaggio della testa di deviazione con strisce di gesso (opzionale con sigillante)	X-C 45 B4 MX	Cemento morbido, Calcestruzzo medio	14 - < 18	0,1	0,1
		Cemento morbido, Calcestruzzo medio	$\geq 18$	0,2	0,2

### 6.2 Stima del tasso di trucioli

Disegno tecnico	Condizione di fissaggio	Tipo di materiale base	Stima del tasso di trucioli [%]
	Legno su calcestruzzo, Fissaggio guida fissa, Fissaggio della testa di deviazione con strisce di gesso (opzionale con sigillante), Fissaggio del binario della testa di deviazione (in via opzionale con sigillante)	Cemento morbido	75 - 90
		Calcestruzzo medio	75 - 90



- Il tasso di trucioli può variare dai valori sopracitati a seconda delle condizioni in cantiere.
- Il tasso di trucioli indica la percentuale di chiodi inseriti correttamente per sostenere il carico.

## 7 ASSICURAZIONE QUALITÀ

### 7.1 Ispezione fissaggio

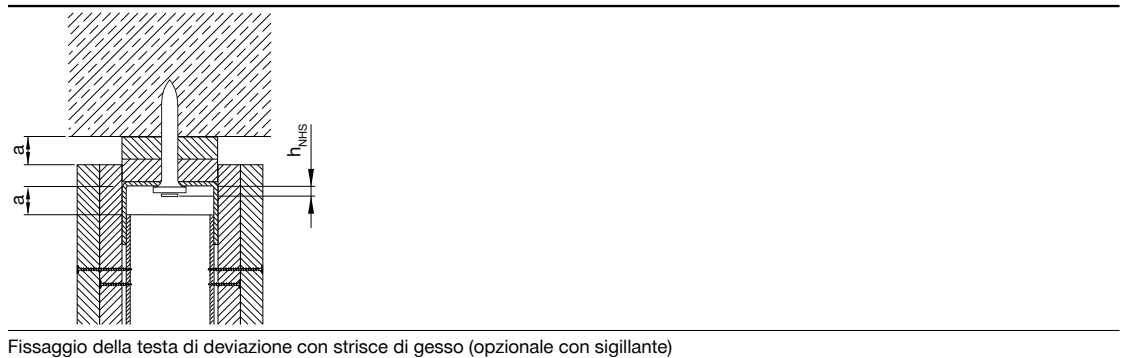
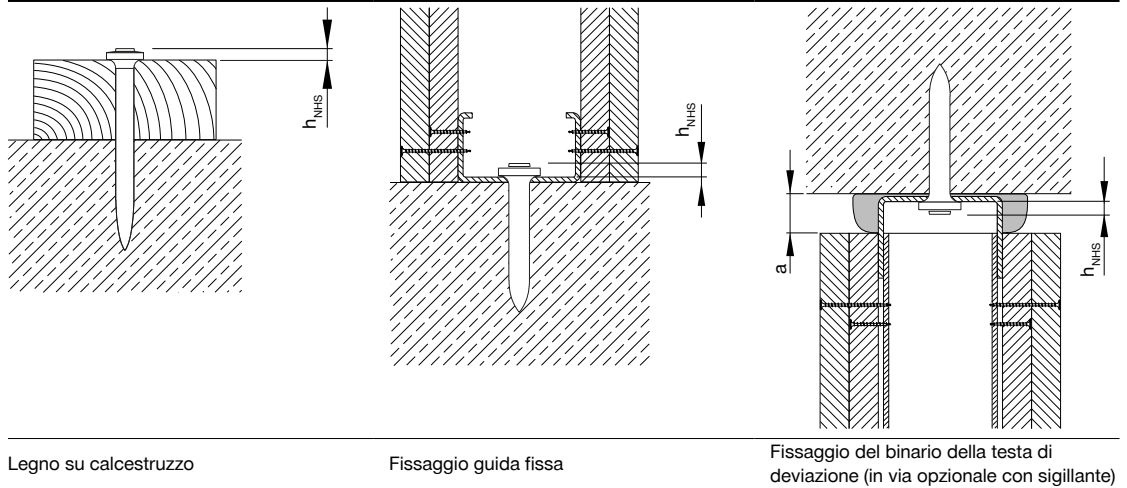

Condizione di fissaggio	Elemento di fissaggio	Spazio della testa di deviazione a [mm]	Distanziatore chiodo h <sub>NHS</sub> [mm]
Legno su calcestruzzo	X-C B4 MX, X-C B3 MX, X-C G3 MX, X-C G2 MX, X-GN MX		≤3
Fissaggio guida fissa	X-C B4 MX, X-C B3 MX, X-C G3 MX, X-C G2 MX, X-GN MX		2 - 5
Fissaggio del binario della testa di deviazione (in via opzionale con sigillante)	X-C B4 MX, X-C B3 MX, X-C G3 MX, X-C G2 MX, X-GN MX	≤20	2 - 3
Fissaggio della testa di deviazione con strisce di gesso (opzionale con sigillante)	X-C 45 B4 MX	≤20	2 - 3



- Gli errori di impostazione evidenti devono essere corretti sostituendo l'elemento di fissaggio, realizzando un nuovo foro.
- Di seguito sono riportate istruzioni brevi che possono variare a seconda dell'applicazione.
- Consultare/seguire sempre le istruzioni allegate al prodotto.

## 8 INFORMAZIONI PER L'ORDINE

### 8.1 Numero articolo e descrizione

Denominazione	Codice articolo	Descrizione
X-C 20 B3 MX	2123993, 2246267	Chiodi per calcestruzzo X-C B3 MX (a nastro)
X-C 24 B3 MX	2123994, 2314526	
X-C 27 B3 MX	2224568	
X-C 30 B3 MX	2149988, 2314527	
X-C 36 B3 MX	2149989	
X-C 20 B4 MX	2361658, 2361663, 2412651, 2412652	Chiodi per calcestruzzo X-C B4 MX (a nastro)
X-C 27 B4 MX	2361659, 2361664, 2412653, 2412654	
X-C 32 B4 MX	2361660, 2361665, 2412655, 2412656	
X-C 39 B4 MX	2361661, 2361666, 2412657, 2412658	
X-C 45 B4 MX	2361662, 2361667, 2412659, 2412760	
X-C 20 G2 MX	2102013	Chiodi per calcestruzzo X-C G2 MX (a nastro)
X-C 27 G2 MX	2102014	
X-C 39 G2 MX	3539617	
X-C 20 G3 MX	2100955, 2100959	Chiodi per calcestruzzo X-C G3 MX (a nastro)
X-C 27 G3 MX	2100956, 2101040	
X-C 32 G3 MX	2100957	
X-C 39 G3 MX	2100958, 2122633	
X-GN 20 MX	2045541, 2064004, 2071406, 226933, 340232	Chiodi per calcestruzzo X-GN MX (a nastro)
X-GN 27 MX	2045540, 2064005, 2071407, 226934, 340230	
X-GN 32 MX	2045542, 2064006, 2071408, 226935, 340233	
X-GN 39 MX	2064007, 340234	



Hilti Aktiengesellschaft  
9494 Schaan, Liechtenstein  
P +423-234 2965

[www.facebook.com/hiltigroup](https://www.facebook.com/hiltigroup)  
[www.hilti.group](https://www.hilti.group)



X-C B4 MX,  
X-C B3 MX,  
X-C G3 MX,  
X-C G2 MX,  
X-GN MX

**Gwoździe do betonu  
(magazynkowane)**

Karta danych

Polski

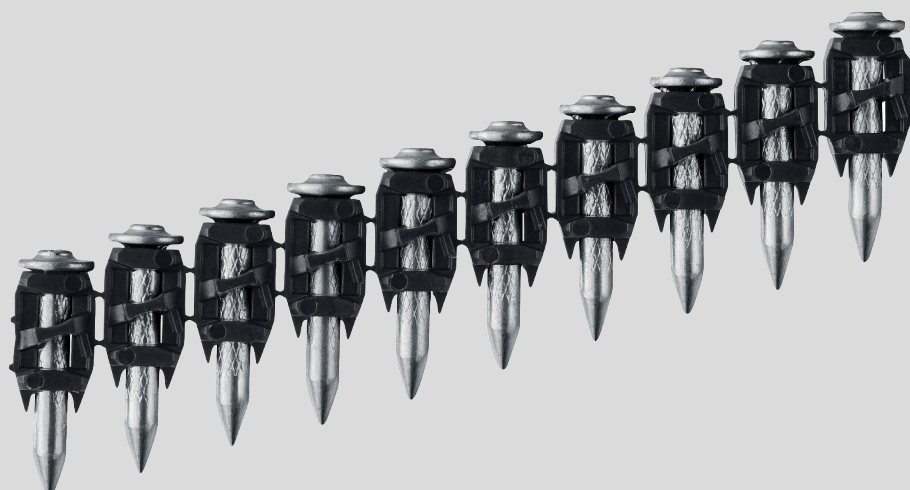





## SPIS TREŚCI

<b>1</b>	<b>Informacje o produkcie</b>	<b>2</b>
1.1	Opis produktu	2
<b>2</b>	<b>Warunki zastosowania</b>	<b>3</b>
2.1	Warunki mocowania	3
2.2	Materiały podłoża	3
2.3	Warunki obciążenia	3
2.4	Warunki środowiskowe	4
<b>3</b>	<b>Dane produktu</b>	<b>4</b>
3.1	Wymiary	4
3.2	Właściwości materiału dla części ze stali węglowej	4
<b>4</b>	<b>Zalecenie systemu</b>	<b>5</b>
4.1	Narzędzie polecane	5
<b>5</b>	<b>Wymagania dotyczące zastosowania</b>	<b>6</b>
5.1	Właściwości zamocowanego materiału	6
5.2	Właściwości materiału podłoża	7
5.3	Zalecana długość gwoździ	7
<b>6</b>	<b>Dane właściwości</b>	<b>8</b>
6.1	Zalecane obciążenia przy obciążeniu kwazistatycznym/statycznym	8
6.2	Ocena współczynnika mocowania	9
<b>7</b>	<b>Zapewnianie jakości</b>	<b>10</b>
7.1	Inspekcja mocowania	10
<b>8</b>	<b>Informacje dotyczące zamawiania</b>	<b>11</b>
8.1	Nr artykułu i opis	11

# 1 INFORMACJE O PRODUKCIE

## 1.1 Opis produktu

Oznaczenie	Cechy
<p>X-C B4 MX</p> 	<ul style="list-style-type: none"> <li>Gwóźdź klasy Premium zapewniający dużą wydajność wykonywania zamocowań w miękkim betonie</li> <li>Rozwiązanie do codziennego mocowania z gwóździem z prasowanym wierzchołkiem</li> </ul>
<p>X-C B3 MX</p> 	<ul style="list-style-type: none"> <li>Gwóźdź klasy Premium zapewniający dużą wydajność wykonywania zamocowań w miękkim betonie</li> <li>Ekonomiczny, standardowy gwóźdź z prasowanym wierzchołkiem</li> </ul>
<p>X-C G3 MX</p> 	<ul style="list-style-type: none"> <li>Gwóźdź klasy Premium zapewniający dużą nośność w miękkim betonie</li> <li>Rozwiązanie do codziennego mocowania z gwóździem z prasowanym wierzchołkiem</li> </ul>
<p>X-C G2 MX</p> 	<ul style="list-style-type: none"> <li>Gwóźdź klasy Premium zapewniający dużą wydajność wykonywania zamocowań w miękkim betonie</li> <li>Ekonomiczny, standardowy gwóźdź z prasowanym wierzchołkiem</li> </ul>
<p>X-GN MX</p> 	<ul style="list-style-type: none"> <li>Gwóźdź klasy Premium zapewniający dużą wydajność wykonywania zamocowań w miękkim betonie</li> <li>Ekonomiczny, standardowy gwóźdź z prasowanym wierzchołkiem</li> </ul>



## 2 WARUNKI ZASTOSOWANIA

### 2.1 Warunki mocowania

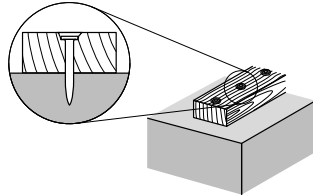

Drewno do betonu

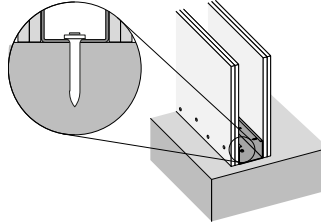

Stałe mocowanie profilu

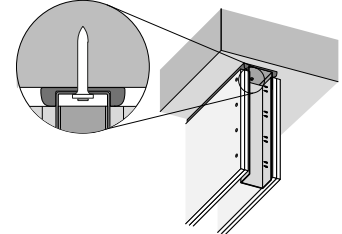

Mocowanie szyny połączenia przesuwnej (opcjonalnie z uszczelniaczem)

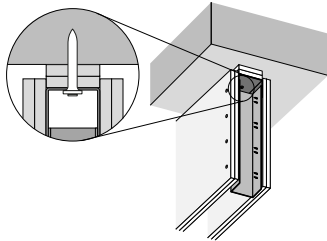

Mocowanie głowicy odchylającej za pomocą pasków gipsowych (opcjonalnie z uszczelniaczem)

### 2.2 Materiały podłoża

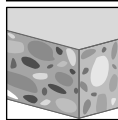

Beton

### 2.3 Warunki obciążenia

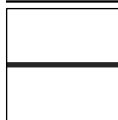

Statyczny/kwazistatyczny

## 2.4 Warunki środowiskowe

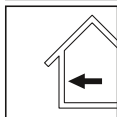

Suche, wewnątrz



- Aby uzyskać więcej informacji, zapoznaj się z informacjami na stronie [Hilti Corrosion Handbook](#).

## 3 DANE PRODUKTU

### 3.1 Wymiary

Rysunek techniczny	Elementy mocujące	Długość główki $L_h$ [mm]	Długość trzcienia $L_s$ [mm]	Średnica trzcienia $d_s$ [mm]	Średnica główki $d_h$ [mm]
	X-C 20 B4 MX	1,8	20	3	6,5
	X-C 27 B4 MX	1,8	27	3	6,5
	X-C 32 B4 MX	1,8	32	3	6,5
	X-C 39 B4 MX	1,8	37,5	2,75	6,3
	X-C 45 B4 MX	1,8	45	2,75	6,3
	X-C 20 B3 MX	1,8	20	3	6,8
	X-C 24 B3 MX	1,9	24	3	6,5
	X-C 27 B3 MX	1,9	27	3	6,5
	X-C 30 B3 MX	1,9	30	3	6,5
	X-C 36 B3 MX	1,8	36	2,75	6,3
	X-C 20 G3 MX	1,9	19	3	6,5
	X-C 27 G3 MX	1,9	27	3	6,5
	X-C 32 G3 MX	1,9	30	3	6,5
	X-C 39 G3 MX	1,9	38,5	2,6	5,8
	X-C 20 G2 MX	1,8	19,05	2,75	6,3
	X-C 27 G2 MX	1,8	27,4	2,75	6,3
	X-C 39 G2 MX	1,9	38,5	2,6	5,8
	X-GN 20 MX	1,9	19	3	6,5
	X-GN 27 MX	1,9	27	3	6,5
	X-GN 32 MX	1,9	32	3	6,5
	X-GN 39 MX	1,9	38,5	2,6	5,8

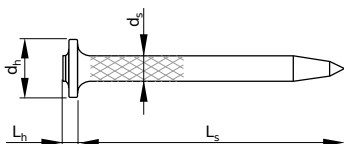

### 3.2 Właściwości materiału dla części ze stali węglowej

Elementy mocujące	Część składowa	Materiał	Powłoka	Grubość powłoki $t_c$ [μm]	Twardość [HRC]	Kategoria korozyjności
X-C B4 MX	Gwóźdź	Stal węglowa	Ocynkowane	≥5	56,5	C1

Elementy mocujące	Część składowa	Materiał	Powłoka	Grubość powłoki	Twardość	Kategoria korozyjności
				t <sub>c</sub> [μm]	[HRC]	
X-C B3 MX	Gwóźdź	Stal węglowa	Ocynkowane	≥5	56,5	C1
X-C G3 MX	Gwóźdź	Stal węglowa	Ocynkowane	≥5	56,5	C1
X-C G2 MX	Gwóźdź	Stal węglowa	Ocynkowane	≥5	56,5	C1
X-GN 20 MX	Gwóźdź	Stal węglowa	Ocynkowane	≥5	53,5	C1
X-GN 27 MX	Gwóźdź	Stal węglowa	Ocynkowane	≥5	53,5	C1
X-GN 32 MX	Gwóźdź	Stal węglowa	Ocynkowane	≥5	53,5	C1
X-GN 39 MX	Gwóźdź	Stal węglowa	Ocynkowane	≥5	56,5	C1

• Kategoria korozyjności w atmosferze, zgodnie z normą EN ISO 9223.

## 4 ZALECENIE SYSTEMU

### 4.1 Narzędzie polecane

Warunek mocowania	Elementy mocujące	Rodzaj urządzenia
Drewno do betonu, Stałe mocowanie profilu, Mocowanie szyny połączenia przesuwne (opcjonalnie z uszczelniaczem)	X-C B4 MX	BX 4-22 (01)
	X-C B3 MX	BX 3-ME, BX 3-IF, BX 3-ME (02), BX 3 (02), BX 3-L (02), BX 3-ME-22, BX 3-L-22, BX 3-22
	X-C G3 MX	GX 3-ME, GX 3
	X-C G2 MX	GX 2
	X-GN MX	GX 120-ME, GX 120
Mocowanie głowicy odchylającej za pomocą pasków gipsowych (opcjonalnie z uszczelniaczem)	X-C 45 B4 MX	BX 4-22 (01)

• Szczegółowe informacje zamieszczono w rozdziale Akcesoria i zgodność materiałów eksploatacyjnych w [Podręcznik techniki kotwienia \(DFTM\)](#)

## 5 WYMAGANIA DOTYCZĄCE ZASTOSOWANIA

### 5.1 Właściwości zamocowanego materiału

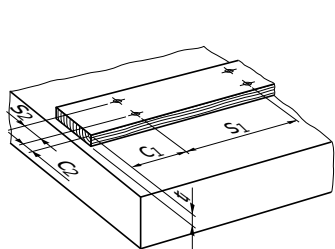

Drewno do betonu

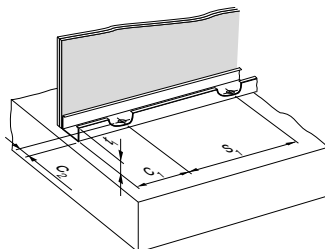

Stałe mocowanie profilu

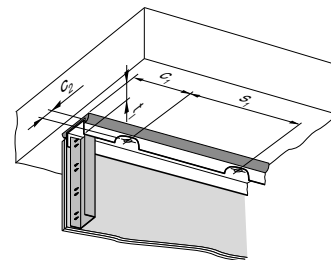

Mocowanie szyny połączenia przesuwnej (opcjonalnie z uszczelniaczem)

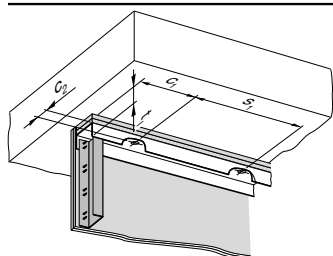

Mocowanie głowicy odchylającej za pomocą pasków gipsowych (opcjonalnie z uszczelniaczem)

Warunek mocowania	Elementy mocujące	Zamocowany materiał	Grubość mocowanego materiału $t_1$ [mm]	Odległość od krawędzi $c_1$ [mm]	Odległość od krawędzi $c_2$ [mm]	Odległość między elementami mocującymi $s_1$ [mm]	Odległość między elementami mocującymi $s_2$ [mm]
Drewno do betonu	X-C B4 MX, X-C B3 MX, X-C G3 MX, X-C G2 MX, X-GN MX	Drewno	$\leq 25$	$\geq 100$	$\geq 22$	180 – 800	$\geq 80$
Stałe mocowanie profilu	X-C B4 MX, X-C B3 MX, X-C G3 MX, X-C G2 MX, X-GN MX	Tor stalowy	$\leq 1$	$\geq 40$		$\leq 600$	$\geq 80$
Mocowanie szyny połączenia przesuwnej (opcjonalnie z uszczelniaczem)	X-C B4 MX, X-C B3 MX, X-C G3 MX, X-C G2 MX, X-GN MX	Szyna stalowa, Hilti CSF-TTS lub uszczelniacz	$\leq 3,5$				
Mocowanie głowicy odchylającej za pomocą pasków gipsowych (opcjonalnie z uszczelniaczem)	X-C 45 B4 MX	Szyna stalowa, płyta gipsowo-kartonowa	$\leq 33,5$				

## 5.2 Właściwości materiału podłoża

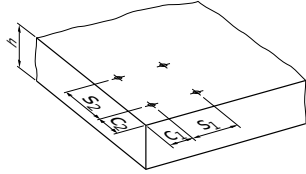

Mocowanie do betonu

Materiał podłoża	Grubość materiału podłoża	Odległość od krawędzi	Odległość od krawędzi	Odległość między elementami mocującymi	Odległość między elementami mocującymi
	h [mm]	c <sub>1</sub> [mm]	c <sub>2</sub> [mm]	s <sub>1</sub> [mm]	s <sub>2</sub> [mm]
Beton	≥ 60	≥ 70	≥ 70	≥ 100	≥ 100

## 5.3 Zalecana długość gwoździ

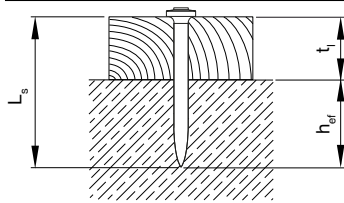

Drewno do betonu

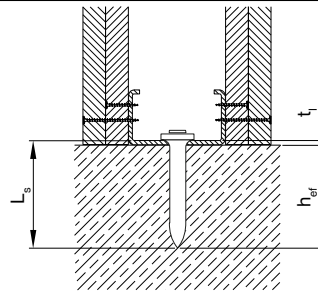

Stałe mocowanie profilu

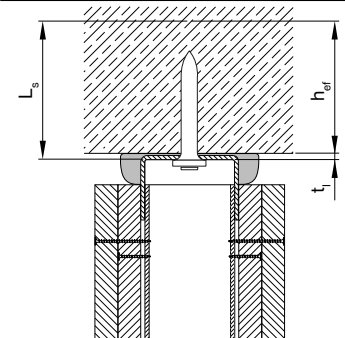

Mocowanie szyny połączenia przesuwnej (opcjonalnie z uszczelniaczem)

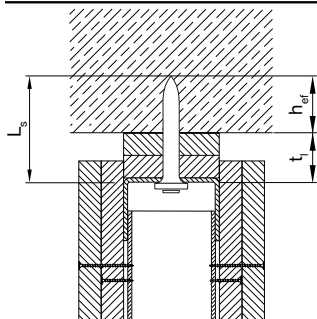

Mocowanie głowicy odchylającej za pomocą pasków gipsowych (opcjonalnie z uszczelniaczem)

Warunek mocowania	Właściwości mocowania	Długość trzpienia	Głębokość osadzenia	Grubość mocowanego materiału
		$L_s$ [mm]	$h_{ef}$ [mm]	$t_f$ [mm]
Drewno do betonu	Mocowanie standardowe	$L_s \geq h_{ef} + t_f$	$\geq 14$	$\leq 25$
	Mocowanie równo z powierzchnią	$L_s \geq h_{ef} + t_f - 3$	$\geq 14$	$\leq 25$
Stałe mocowanie profilu	Mocowanie standardowe	$L_s \geq h_{ef} + t_f$	$\geq 14$	$\leq 1$
Mocowanie szyny połączenia przesuwne (opcjonalnie z uszczelniaczem)	Mocowanie standardowe	$L_s \geq h_{ef} + t_f$	$\geq 14$	$\leq 3,5$
Mocowanie głowicy odchylającej za pomocą pasków gipsowych (opcjonalnie z uszczelniaczem)	2 warstwy płyt	$L_s \geq h_{ef} + t_f$	$\geq 14$	$\leq 33,5$

## 6 DANE WŁAŚCIWOŚCI

### 6.1 Zalecane obciążenia przy obciążeniu kwazistatycznym/statycznym

Warunek mocowania	Elementy mocujące	Rodzaj materiału podłoża	Głębokość osadzenia	Obciążenie rozciągające	Obciążenie ścinające
			$h_{ef}$ [mm]	$N_{rec}$ [kN]	$V_{rec}$ [kN]
Stałe mocowanie profilu, Mocowanie szyny połączenia przesuwne (opcjonalnie z uszczelniaczem), Drewno do betonu	X-C B4 MX, X-C B3 MX, X-C G3 MX, X-C G2 MX, X-GN MX	Beton o wyższym stosunku w/c, Beton średni	14 - < 18	0,1	0,1
		Beton o wyższym stosunku w/c, Beton średni	$\geq 18$	0,2	0,2
Mocowanie głowicy odchylającej za pomocą pasków gipsowych (opcjonalnie z uszczelniaczem)	X-C 45 B4 MX	Beton o wyższym stosunku w/c, Beton średni	14 - < 18	0,1	0,1
		Beton o wyższym stosunku w/c, Beton średni	$\geq 18$	0,2	0,2

## 6.2 Ocena współczynnika mocowania

Rysunek techniczny	Warunek mocowania	Rodzaj materiału podłoża	Ocena współczynnika mocowania [%]
	Stałe mocowanie profilu, Mocowanie szyny połączenia przesuwnej (opcjonalnie z uszczelniaczem), Mocowanie głowicy odchylającej za pomocą pasków gipsowych (opcjonalnie z uszczelniaczem), Drewno do betonu	Beton o wyższym stosunku w/c	75-90
		Beton średni	75-90



- Szybkość przyklejania może różnić się od powyższych wartości w zależności od warunków w miejscu pracy.
- Współczynnik mocowania oznacza procent gwoździ, które zostały prawidłowo wbite, aby przenosić obciążenie.

## 7 ZAPEWNIANIE JAKOŚCI

### 7.1 Inspekcja mocowania

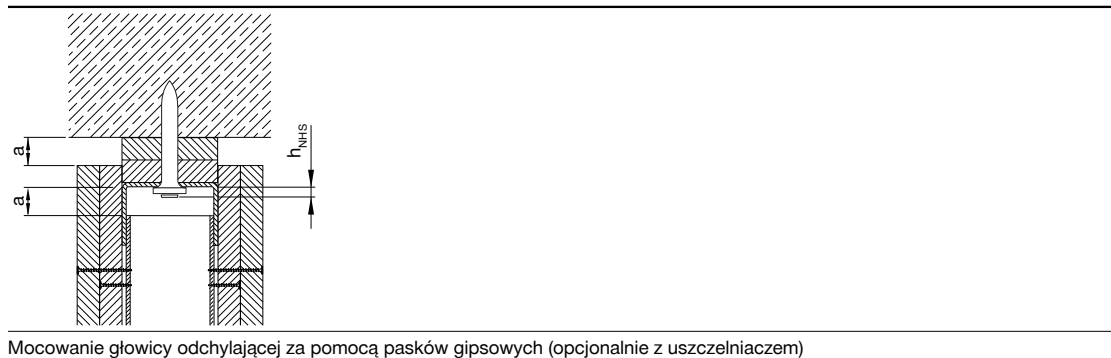
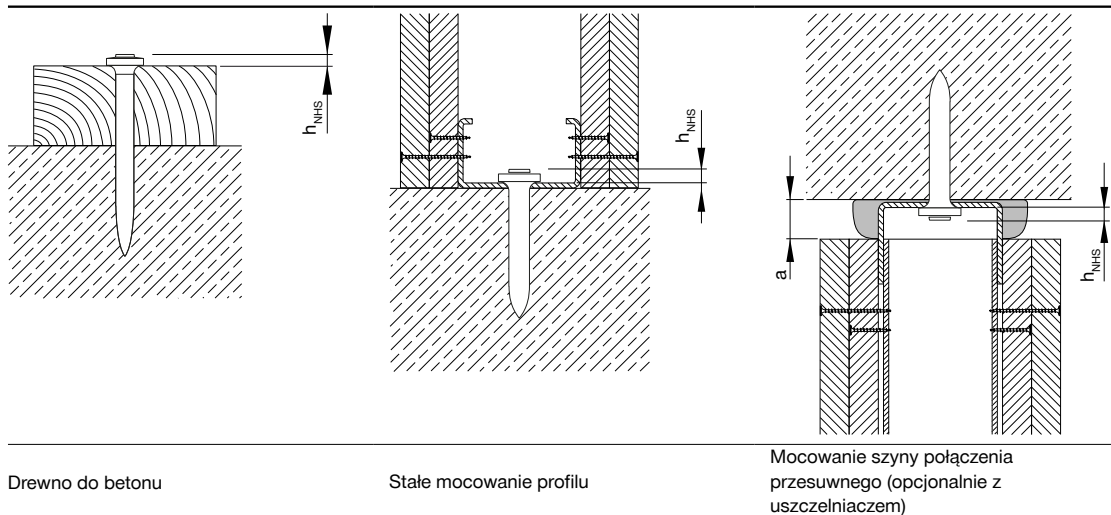

Warunek mocowania	Elementy mocujące	Szczelina połączenia przesuwnej	Wystawienie łącznika
		a [mm]	$h_{NHS}$ [mm]
Drewno do betonu	X-C B4 MX, X-C B3 MX, X-C G3 MX, X-C G2 MX, X-GN MX		≤3
Stałe mocowanie profilu	X-C B4 MX, X-C B3 MX, X-C G3 MX, X-C G2 MX, X-GN MX		2-5
Mocowanie szyny połączenia przesuwnej (opcjonalnie z uszczelniaczem)	X-C B4 MX, X-C B3 MX, X-C G3 MX, X-C G2 MX, X-GN MX	≤20	2-3
Mocowanie głowicy odchylającej za pomocą pasków gipsowych (opcjonalnie z uszczelniaczem)	X-C 45 B4 MX	≤20	2-3



- Widoczne wadliwe zamocowania trzeba zastąpić nowymi elementami mocującymi, nie w tym samym otworze.
- Niniejszy dokument to wersja skrócona instrukcji, mogących różnić się w zależności od zastosowania.
- Należy zawsze przestrzegać instrukcji dołączonych do danego produktu.



## 8 INFORMACJE DOTYCZĄCE ZAMAWIANIA

### 8.1 Nr artykułu i opis

Oznaczenie	Nr artykułu	Opis
X-C 20 B3 MX	2123993, 2246267	Gwoździe X-C B3 MX do betonu (magazynkowane)
X-C 24 B3 MX	2123994, 2314526	
X-C 27 B3 MX	2224568	
X-C 30 B3 MX	2149988, 2314527	
X-C 36 B3 MX	2149989	Gwoździe X-C B4 MX do betonu (magazynkowane)
X-C 20 B4 MX	2361658, 2361663, 2412651, 2412652	
X-C 27 B4 MX	2361659, 2361664, 2412653, 2412654	
X-C 32 B4 MX	2361660, 2361665, 2412655, 2412656	
X-C 39 B4 MX	2361661, 2361666, 2412657, 2412658	
X-C 45 B4 MX	2361662, 2361667, 2412659, 2412760	Gwoździe X-C G2 MX do betonu (magazynkowane)
X-C 20 G2 MX	2102013	
X-C 27 G2 MX	2102014	
X-C 39 G2 MX	3539617	Gwoździe X-C G3 MX do betonu (magazynkowane)
X-C 20 G3 MX	2100955, 2100959	
X-C 27 G3 MX	2100956, 2101040	
X-C 32 G3 MX	2100957	
X-C 39 G3 MX	2100958, 2122633	Gwoździe X-GN MX do betonu (magazynkowane)
X-GN 20 MX	2045541, 2064004, 2071406, 226933, 340232	
X-GN 27 MX	2045540, 2064005, 2071407, 226934, 340230	
X-GN 32 MX	2045542, 2064006, 2071408, 226935, 340233	
X-GN 39 MX	2064007, 340234	



Hilti Aktiengesellschaft  
9494 Schaan, Liechtenstein  
P +423-234 2965

[www.facebook.com/hiltigroup](https://www.facebook.com/hiltigroup)  
[www.hilti.group](https://www.hilti.group)